



www.rintal.com

GROUP RINTAL

Over forty years of history in the world of stairs

Rintal was founded in 1974 in Forlì and for more than 40 years has been a world leader in stairs thanks to the development of innovative Solutions for:

PRODUCT DESIGN

MADE IN ITALY

QUALITY OF MATERIALS

QUALITY OF THE FINISHES

PRE AND AFTER SALES ASSISTANCE

BY TECHNICAL CONSULTANTS

INSTALLATION SERVICE

With production facilities of over 10,000 square meters Rintal creates interior and exterior stairs, mezzanines, railings and coverings for concrete stairs.

NB: qui no misura in pollici?

The Rintal Group operates with two brands, each one designed to respond to specific needs of style, functionality and budget:



custom stairs designed to respond to the different needs of Architects, Designers, Builders, Design-build Contractors and Private Clients



loft ladders which combine functionality and security in products that are simple and easy to use

RINTAL SMART DESIGN

Is the new contemporary collection that brings together beauty, versatility, innovation, modularity and technology in a unique combination that surprises and delights.

Rintal Smart Design is synonymous with:

- **Easy design**

a proprietary software tool allows a very easy configuration of stairs project in real time.

- **Custom Solutions**

it is possible to customize stair projects by choosing among the many accessories available.

- **Short Delivery time**

production standardization reduces delivery time.

- **Easy transport**

all stair parts such as structures, steps and railings fit into a single box.

- **Adaptability to all spaces**

the system for adjusting the steps in height (rise) and the depth (run) allows to adapt the staircase to the space available.

The right compromise between ease of climb and dimensions in space is achieved.

- **Easy assembling**

Do it yourself can install the stair simply by following installation and video instructions.

PRODUCT RANGE

INTERIORS STAIRCASES

OPEN RISER STAIRCASES

SPACE SAVING STAIRCASES

SPIRAL STAIRCASES

COMPOSITITY

p. 12



KNOCK

p. 22



CANTILEVER

p. 30



MINI

p. 40



SMALL

p. 46



HOOP

p. 54



PHOLA

p. 60



TEKLA

p. 66



GAMIA METAL

p. 72



OUTDOOR STAIRCASES

SPIRAL STAIRCASES

EXTERIOR ZINK

p. 78



HOW TO SELECT

THE PERFECT STAIRCASE

01. COLLECT ALL DATA

HEIGHT FROM FLOOR TO FLOOR

Determine the distance from the finished floor of the lower floor to the finished floor of the upper floor and the thickness of the ceiling slab.

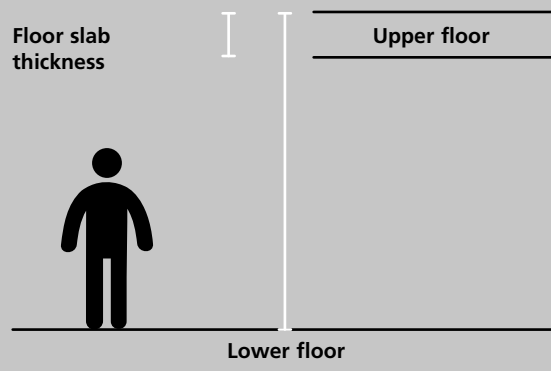

SIZE OF THE STAIRWELL

Measure the dimensions of the space where the stairs will be positioned always considering the architectural elements such as walls, doors, windows, radiators etc., which may obstruct the position of the stairs.

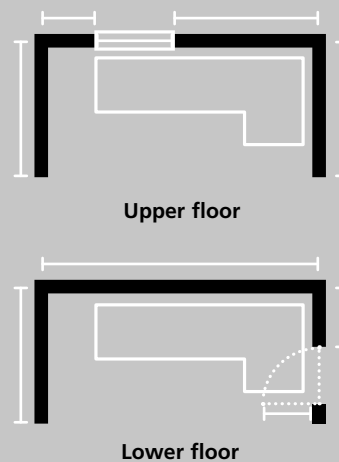

SIZE OF THE OPENING ON THE UPPER FLOOR

If the opening already exists: measure the dimensions of the opening of the upper floor. For the round opening, measure the diameter. For all other types, measure all sides.

If the opening has not yet been made: identify the type of stair on the basis of the dimensions of the stairwell and then determine the position and the size of the opening.

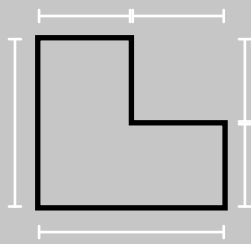

- Open riser
- Space saving

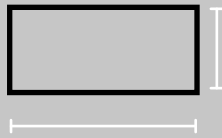

- Open riser
- Space saving

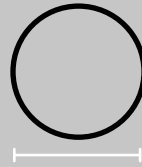

- Spiral round plan (No Exterior Zink)

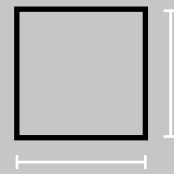

- Open riser
- Spiral square
- Spiral round

02. CHOOSE THE TYPE OF STAIRS



Open riser



Space saving



Spiral round



Spiral square

GLOSSARY

TYPE OF STAIRS

Open riser staircase: stair characterized by a series of straight winder or platform, which allow the staircase to change direction with a 90° turn. The support is composed of a structure under the steps.

Space saving staircase: open staircase characterized by small steps, specially shaped to allow a steep incline of the staircase. The support is composed of a structure under the steps.

Spiral Staircase: staircase characterized by steps and by a final landing, fixed to a central column.

Configuration: shape of the finished staircase. Open staircases can have linear configuration, with one turn or with two turns. Spiral staircases have two types of configurations: round or square.

MAIN COMPONENTS OF THE STAIRCASE

Structure: modular elements in steel joined together to support the steps.

Steps: wooden elements and the structure are the building blocks of the staircase; the railing is fixed to the steps. In the open staircases, the steps are linear, triangular or square in case the direction of the stairs changes by 90°. In the space-saving staircases they are staggered and shaped in order to reduce the landing space of the stair. In the spiral staircases they are arranged circularly around the central column.

Landing: in space saving staircases and in some models of open staircases is used to change direction (in correspondence of the turn). In the spiral staircases this corresponds to the last step positioned at the landing of the stair, it can be adapted during installation at any ceiling slab opening (triangular, trapezoidal or circular).

Railing: inclined parapet positioned to the side of the steps to prevent any possible fall while ascending or descending the staircase.

Balustrade: horizontal parapet positioned on the upper floor to prevent possible fall on the lower level.

MAIN DIMENSIONS OF THE STAIRCASE

Width (open rise and space saving staircase): overall width of the stair, i.e. the width of the step including the railing.

Diameter (spiral staircase): diameter of the stair including the railing.

Rise: vertical distance between the surface of two successive steps.

This distance is adjustable depending on the default values that vary from stair to stair and that have been established on the basis of the common stair code.

By changing the value of the rise, the total height of the stairs varies: the higher the number of steps, the smaller the value of the rise.

In the open and space-saving stairs the number of rises is equal to the number of steps plus one, the last step to the upper floor landing is installed a step below the slab (the distance between this step and the flooring of the upper floor is equal to the rise).

In the spiral staircases the number of rises is equal to the number of steps: the top landing is installed at the same level as the flooring of the upper floor.

Run: depth of the step from the front edge of the step up to the projection of the front edge of the next step.

In the open stairs the tread is adjustable according to the default values on the basis of the model. The adjustment occurs by moving the step backward or forward in the installation phase.

STAIRCASE AREA

Stairwell: vertical and horizontal space provided and available for the position of the staircase.

Ceiling slab opening: opening of the ceiling slab for the installation of the staircase.

It can be square, rectangular, L shape, circular, or may be a direct landing to the ceiling slab.

Height between the floors: vertical distance that goes from the finished flooring of the lower level to the finished flooring of the upper level.



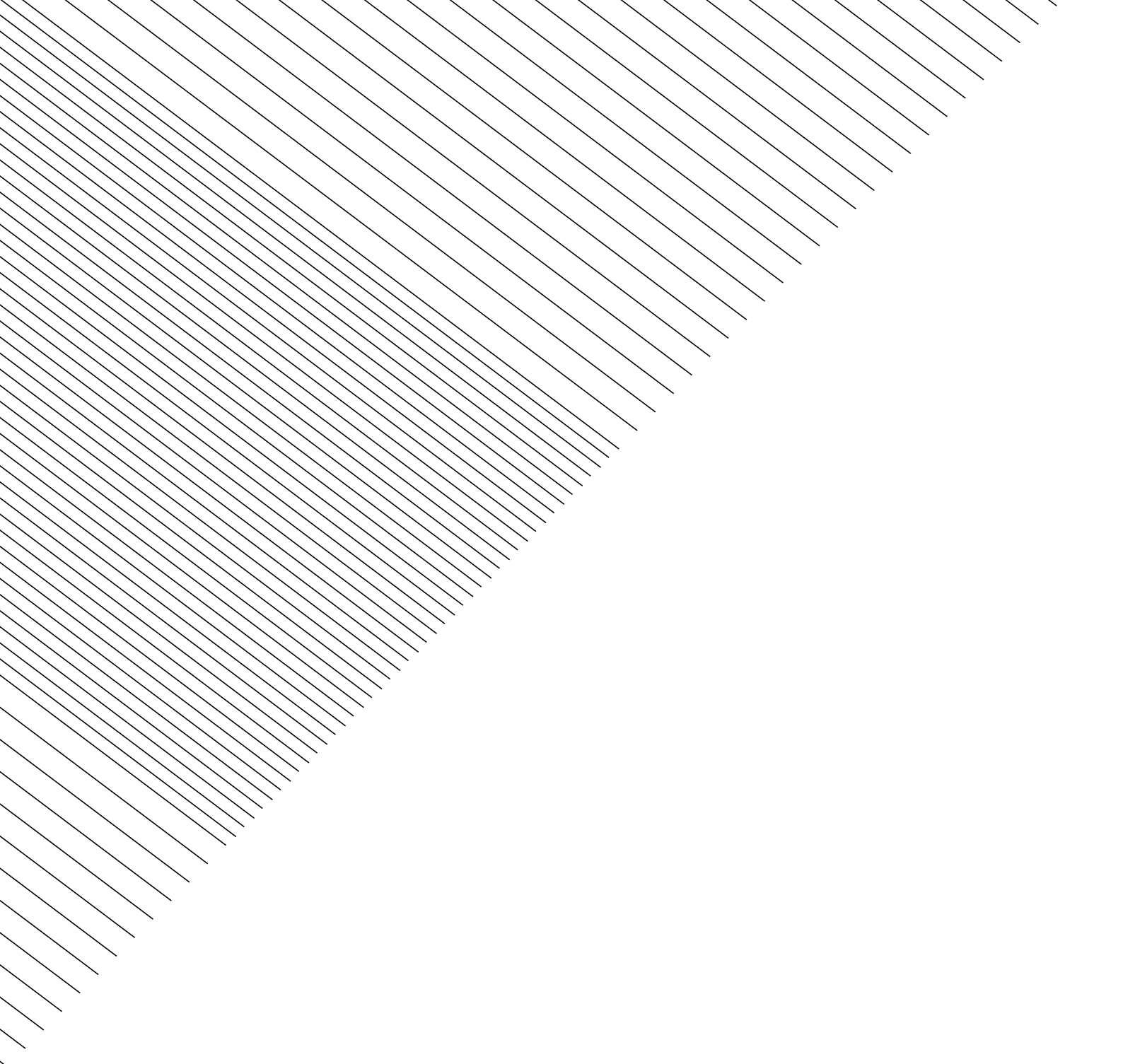

OPEN RISE STAIRCASES

COMPOSIT

The open rise staircase which combines design and versatility in an exclusive, patented solution, bringing together the aesthetic appeal of custom stairs and the benefits of modular solutions.

INTERNATIONAL PATENTED





**Previous pages**

Composity 13 steps, straight configuration.

Steps and handrails Walnut 25, structure and railing (model Minimal) white.

Above

Detail of the mounting of the railing Minimal on the step. Steps and handrails Walnut 25, structure and railing (model Minimal) white.

Left page

Detail of the landing. Steps and handrail Natural 12, anthracite grey structure and railings (Minimal model).

Left

Close-up of steps. Steps and handrail Walnut 25, white structure and railings (Minimal model).

INTERNATIONAL PATENTED







**Above**

Close-up of how the vertical rails are fixed to the step. Steps and handrail Sand 27, anthracite grey structure and railing.

Below

Close-up of the structure and anchoring to the step. Steps and handrail Natural 12, white structure and railings.

Previous pages

Composity 12 steps, configuration with one turn (landing). Steps and handrails White 84, structure and railing (model with vertical columns) white.

Left

Composity 12 steps, configuration with 1 turn. Steps and handrails Walnut 25, structure and railing (model with vertical columns) white. Close-up of turn created with 3 space-saving steps.

**INTERNATIONAL PATENTED**

MATERIALS AND COLORS

STEPS

- Solid beech wood, 1' 5/8" (40 mm) thickness
- No knots or splits, maximum stability and mechanical strength thanks to Finger Joint technology
- Non-toxic water-based coating: 3 layers of paint

HANDRAIL

- In solid beech wood in same colour as steps

STRUCTURE

- Steel modular elements
- Powder coated with matt scratch proof finish

RAILING (two models)

- Steel vertical columns painted in the same colour as the structure (distance between the columns less than 3' 7/8" - 10 cm)
- Painted steel uprights in same colour as structure and satin finish horizontal stainless steel cables

Wood colour (steps and handrail)

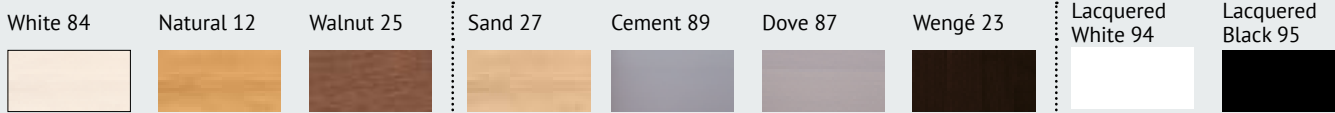

Steel colour (structure and railing)



CONFIGURATIONS

STRAIGHT



WITH 1 TURN

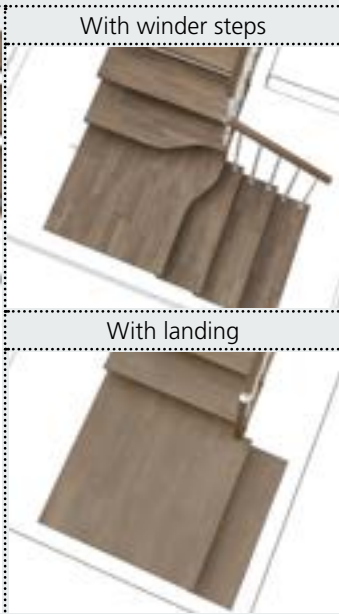

WITH 2 TURNS

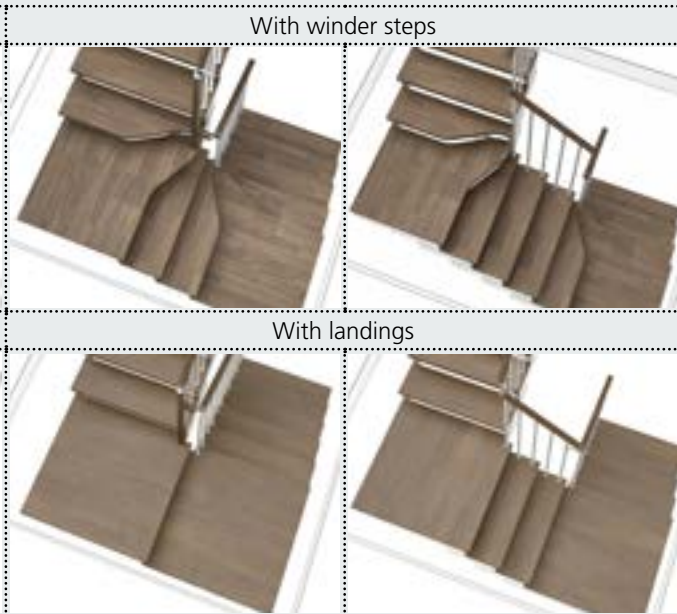

PACKAGE

1 box

=

1 complete staircase with 12 steps

Structure, steps, railing (internal side), handrail

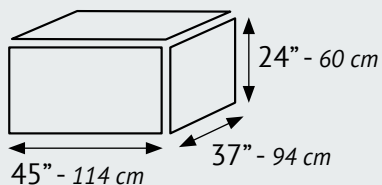

Choose between:

Straight staircase:

- 12 straight steps

Staircase with 1 turn:

- 9 straight steps + 3 winder steps
- 11 straight steps + 1 landing

Staircase with 2 turns:

- 6 straight steps + 6 winder steps
- 10 straight steps + 2 landings

The measures of the box may vary

MEASUREMENTS valid for all the configurations

The **SYSTEM FOR ADJUSTING THE HEIGHT BETWEEN THE STEPS (RISE)** allows you to:

- Obtain different heights between floors with the same number of steps.
- Obtain the height between the floors as required with more or fewer steps (this means you can find the best compromise between the step height and the space occupied by the staircase).

N. STEPS	HEIGHT BETWEEN FLOORS (H)
9 steps 1 box	Min. 5' 9" - 175 cm Max. 7' 2" - 220 cm (Max. 8' 1/2" - 245 cm)
10 steps 1 box	Min. 6' 4" - 193 cm Max. 7' 11" - 242 cm (Max. 8' 10" - 269 cm)
11 steps 1 box	Min. 6' 11" - 210 cm Max. 8' 8" - 264 cm (Max. 9' 7 3/4" - 294 cm)
12 steps 1 box	Min. 7' 6" - 228 cm Max. 9' 5" - 286 cm (Max. 10' 5 1/4" - 318 cm)
13 steps 1 box + 1 extra step	Min. 8' - 245 cm Max. 10' 1" - 308 cm (Max. 11' 3" - 343 cm)
14 steps 1 box + 2 extra steps	Min. 8' 7" - 263 cm Max. 10' 10" - 330 cm (Max. 12' 1/2" - 367 cm)
15 steps 1 box + 3 extra steps	Min. 9' 2" - 280 cm Max. 11' 6" - 352 cm (Max. 12' 10 3/8" - 392 cm)
16 steps 1 box + 4 extra steps	Min. 9' 9" - 298 cm Max. 12' 3" - 374 cm (Max. 13' 7 3/4" - 416 cm)

Add more steps to reach greater heights.

- H = Finished floor to finished floor height.
- Top step fixed one rise below finished upper floor.
- Ceiling opening width: staircase width + 2" (5 cm).

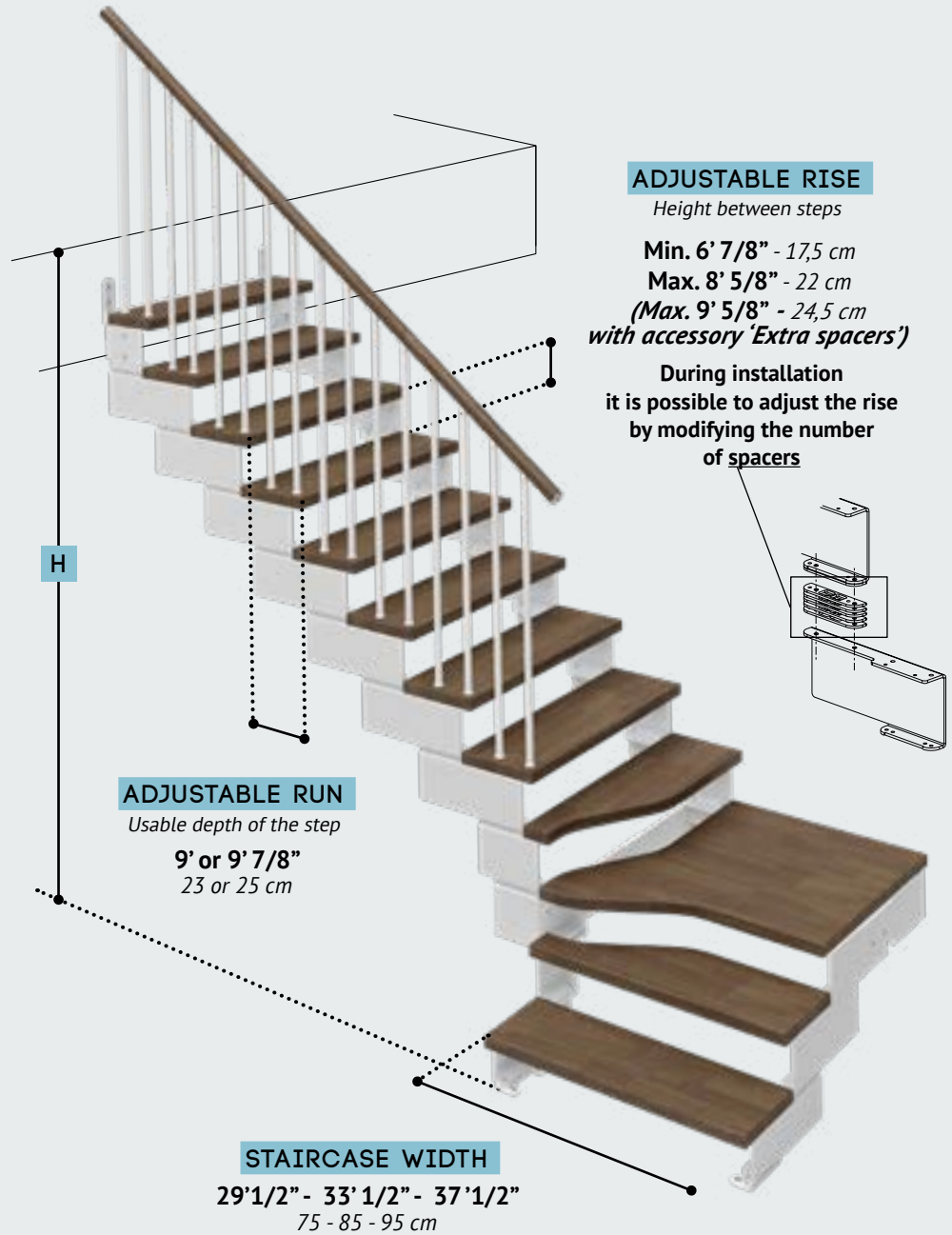

DIRECTION OF ASCENT

Clockwise

Counter clockwise

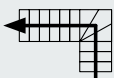
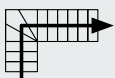

TURN POSITION

Bottom

Middle

Top

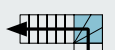

ACCESSORIES

Extra step (with structure and railing).

Railing for 3 steps (External side).

Balustrade for upper floor 39" (100 cm).

Extra spacers (to reach the max rise of 9' 5/8" - 24,5 cm)

Safety bars under steps (wood listel) (available for linear steps and platforms - no for winder steps).

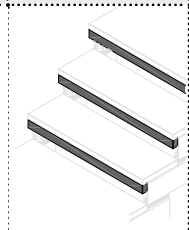
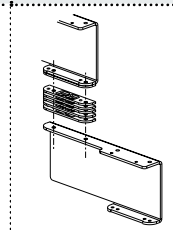
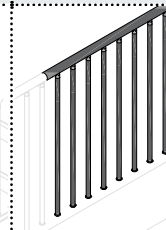
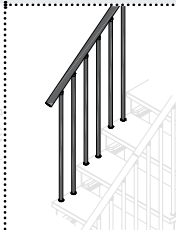
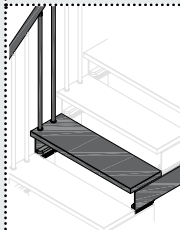

KNOCK

The modular open rise staircase, designed by Giugiaro Architecture that combines a solid steel structure to the possibility to install an integrated LED lighting system.





Previous pages

Knock 13 steps, configuration with 1 turn. Steps and handrail White 84, white structure and railing. Integrated lighting in the spacers.



Left

Close-up of structure and floor support. Steps and handrail White 84, white structure and railing.

Right page

Knock 12 steps, configuration with 2 turns. Steps and handrail Sand 27, white structure and railing.

Below

Detail of the structure. Steps and handrail White 84, white structure and railing.







Left page

*Knock 12 steps, configuration with 1 turn.
Steps and handrail Walnut 25, anthracite
grey structure and railing.*

Below

*Detail of the structure and of the spacers
with integrated lighting. Steps and handrail
Walnut 25, white structure and railing.*



MATERIALS AND COLORS

STEPS

- Solid beech wood, 1' 5/8" (40 mm) thickness
- No knots or splits, maximum stability and mechanical strength thanks to Finger Joint technology
- Non-toxic water-based coating: 3 layers of paint

HANDRAIL

- In solid beech wood in same colour as the steps

STRUCTURE

- Steel modular elements
- Powder coated with matt scratch proof finish

RAILING (two models)

- Steel vertical columns painted in the same colour as the structure (distance between the columns less than 3' 7/8" - 10 cm)
- Painted steel uprights in same colour as structure and satin finish horizontal stainless steel cables

Wood colour (steps and handrail)

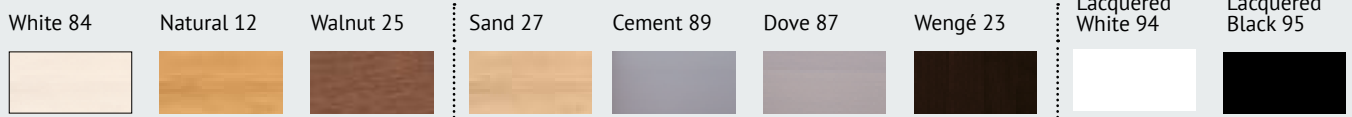

Steel colour (structure and railing)

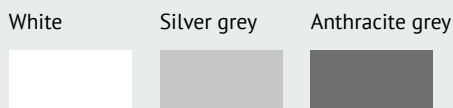

CONFIGURATIONS

STRAIGHT



WITH 1 TURN



WITH 2 TURNS

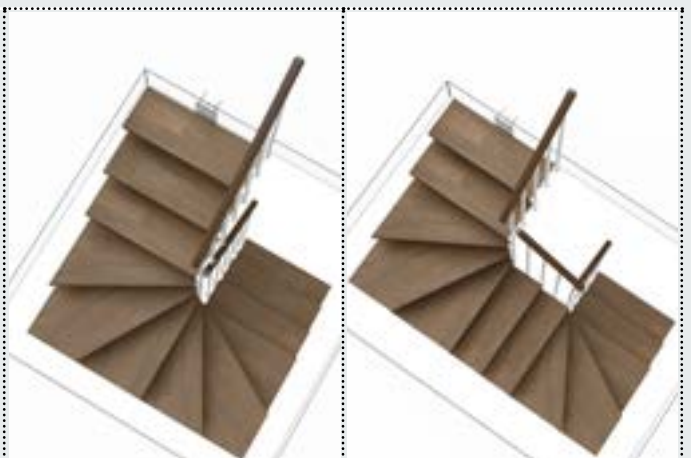

PACKAGE

1 box

=

1 complete staircase with 12 steps

Structure, Steps, Railing (Internal side), Handrail

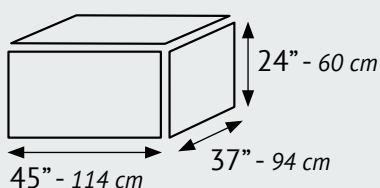

The measures of the box may vary

Choose between:

Straight staircase:

12 straight steps

Staircase with 1 turn:

9 straight steps + 3 winder steps

Staircase with 2 turns:

6 straight steps + 6 winder steps

DIRECTION OF ASCENT

Clockwise

Counter clockwise

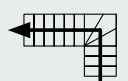
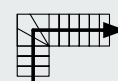

TURN POSITION

Bottom

Middle

Top

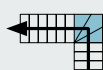

MEASUREMENTS valid for all the configurations

The **SYSTEM FOR ADJUSTING THE HEIGHT BETWEEN THE STEPS (RISE)** allows you to:

- Obtain different heights between floors with the same number of steps.
- Obtain the height between the floors as required with more or fewer steps (this means you can find the best compromise between the step height and the space occupied by the staircase).

N. STEPS	HEIGHT BETWEEN FLOORS (H)
10 steps 1 box	Min. 6' 8 3/8" - 204 cm Max. 8' 1/8" - 244 cm (Max. 8' 7 7/8" - 264 cm)
11 steps 1 box	Min. 7' 4" - 223 cm Max. 8' 9" - 266 cm (Max. 9' 5 3/8" - 288 cm)
12 steps 1 box	Min. 7' 11" - 241 cm Max. 9' 5 3/4" - 289 cm (Max. 10' 3 1/2" - 313 cm)
13 steps 1 box +1 extra step	Min. 8' 6" - 260 cm Max. 10' 2 1/2" - 311 cm (Max. 11' 5/8" - 337 cm)
14 steps 1 box +2 extra steps	Min. 9' 1 1/2" - 278 cm Max. 10' 11 1/2" - 334 cm (Max. 11' 10 1/2" - 362 cm)
15 steps 1 box +3 extra steps	Min. 9' 9" - 297 cm Max. 11' 8" - 356 cm (Max. 12' 8" - 386 cm)
16 steps 1 box +4 extra steps	Min. 10' 4" - 315 cm Max. 12' 5 1/4" - 379 cm (Max. 13' 5 3/4" - 411 cm)

Add more steps to reach greater heights.

- H = Finished floor to finished floor height.
- Top step fixed one rise below finished upper floor.
- Ceiling opening width: staircase width + 2" (5 cm).

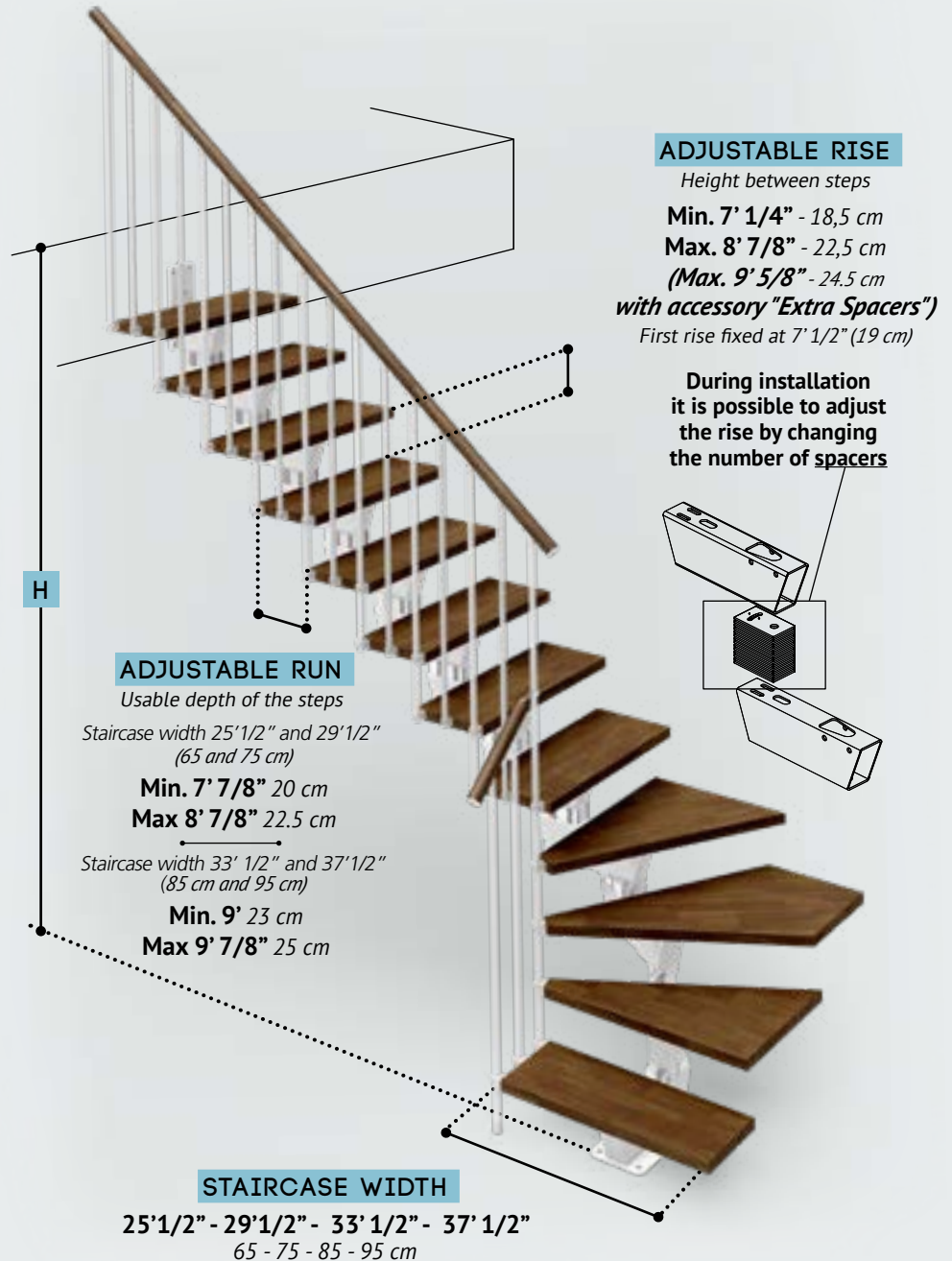

ACCESSORIES

Extra step (with structure and railing).	Railing for 3 steps (External side).	Balustrade for upper floor 39" (100 cm).	Lateral support.	Safety bars under step.	Extra spacers (to reach the max rise of 9' 5/8" - 24,5 cm)	LED lighting between the steps.

CANTILEVER

Suspended steps made in solid wood
for contemporary and minimal environments,
designed to confer lightness to any architecture.







Previous pages

13 steps Cantilever configuration with 1 landing. Steps White 84, white structure.

Left page

14 steps Cantilevers, rectilinear configuration. Steps Walnut 25, white structure.

**Above**

Detail step and wall fixing.
Steps Walnut 25, white structure.

Subsequent Pages

14 steps Cantilevers, rectilinear configuration. Steps White 84, white structure.





MADE IN ITALY

MATERIALS AND COLORS

STEPS

- In solid beech wood
- No knots or splits, maximum stability and mechanical strength thanks to Finger Joint technology
- Cantilever with recesses arranged to receive the steel structure fixed to the wall
- Non-toxic water-based coating: 3 layers of paint

STRUCTURE

- Modular steel elements to fix to the wall
- Powder coated with matt scratch proof finish

RAILING

- For safety reasons it is appropriate to install on the steps a railing to be bought separately

Wood colour (steps)

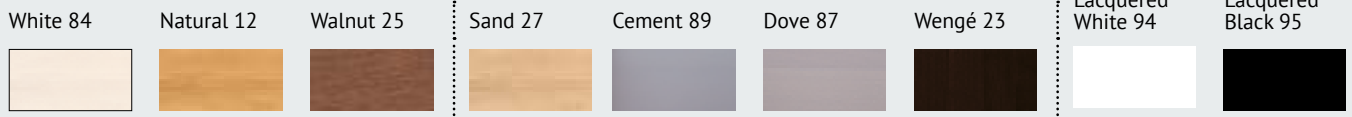

Steel colour (structure)

White



CONFIGURATIONS

STRAIGHT

WITH 1 TURN

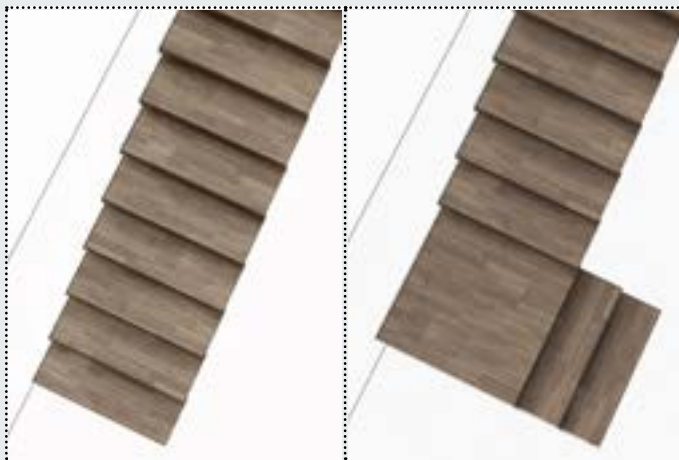

PACKAGE

1 box = 1 step Structure, steps and fixings

At one's choice between:

Linear Step

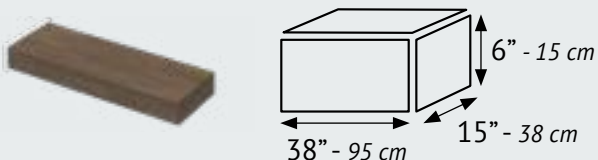

Landing

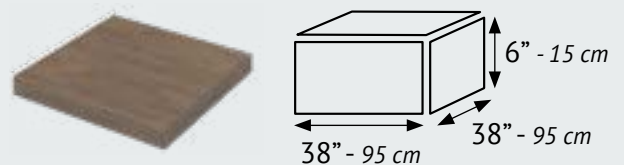

The measures of the box may vary

MEASUREMENTS valid for all the configurations

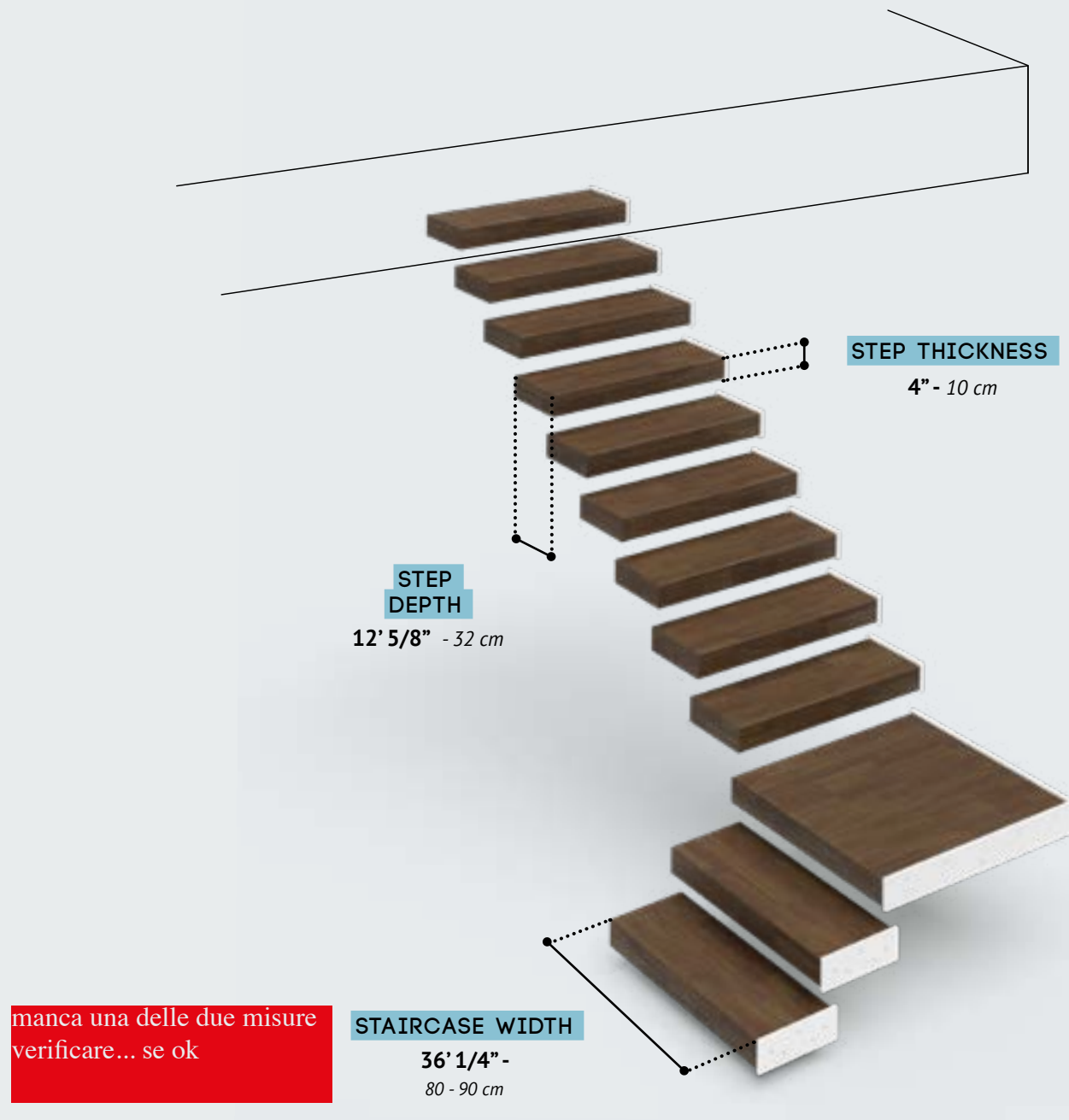

- Top step fixed one rise below finished upper floor.
- Ceiling opening width: staircase width + 2" (5 cm).



ATTENTION

Consult a structural engineer to make sure the walls where the steps will be attached to are load-bearing.

DIRECTION OF ASCENT

Clockwise

Counter clockwise

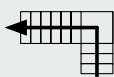
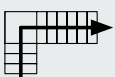

TURN POSITION

Bottom

Middle

Top

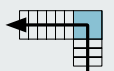



SPACE SAVING STAIRCASES

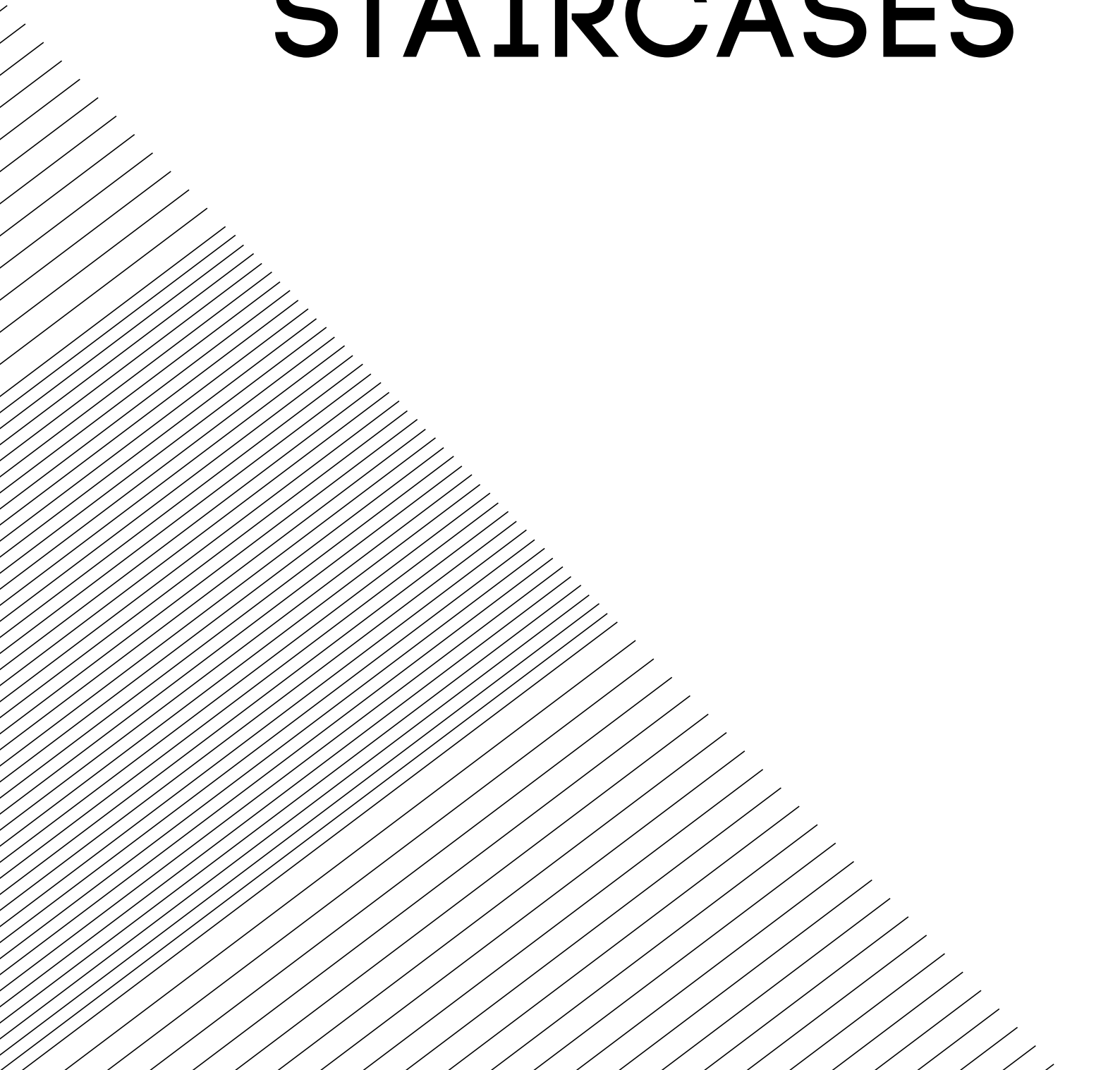

MINI

The space-saving staircase with steps that have been shaped or staggered to optimize the space and ascent whilst occupying the least possible space. The steps are made of solid beech wood and come with a variety of color choices.







Left page
Close-up of step shape with alternating tread. Steps and handrail Walnut 25, silver grey structure and railing.

Previous page
Mini 13 steps, configuration with one turn. Steps and handrail Natural 12, white structure and railings.

Below
Close-up of space-saving landing. Steps and handrail Natural 12, white structure and railings.



MATERIALS AND COLORS

STEPS

- Solid beech wood, 1' 5/8" (40 mm) thickness
- No knots or splits, maximum stability and mechanical strength thanks to Finger Joint technology
- Non-toxic water-based coating: 3 layers of paint

HANDRAIL

- In solid beech wood in same colour as steps

STRUCTURE

- Steel modular elements
- Powder coated with scratch proof finish

RAILING

- Steel vertical columns painted in the same colour as the structure (distance between the columns less than 3' 7/8" - 10 cm)

Wood colour (steps and handrail)

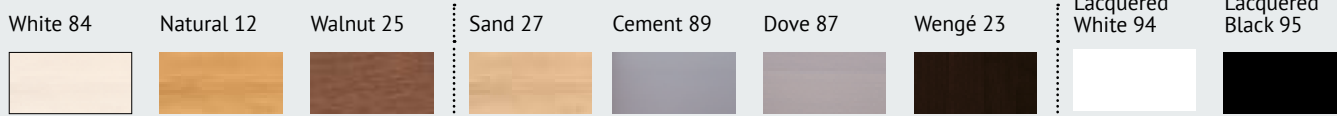

Steel colour (structure and railing)



CONFIGURATIONS

STRAIGHT

WITH 1 TURN

WITH 2 TURNS

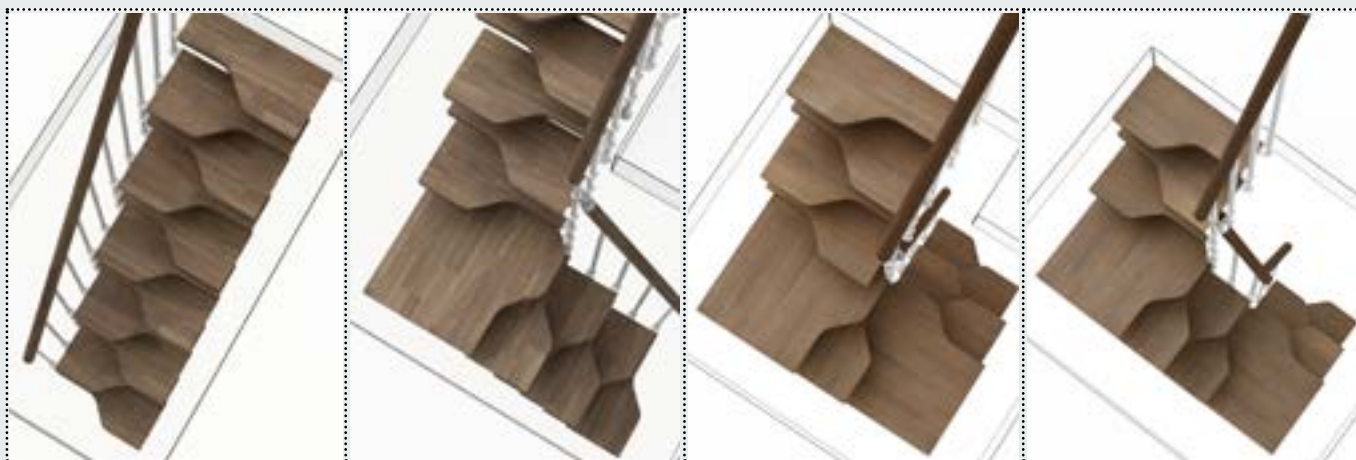

STAGGERED AND SHAPED STEPS: reduce the space occupied by the staircase without sacrificing comfort.

PACKAGE

1 box

=

1 complete staircase with 11 steps

Structure, steps, railing (internal side), handrail

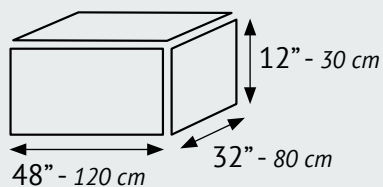

Choose between:

Straight staircase: 11 straight steps

Staircase with 1 turn: 10 straight steps + 1 landing

Staircase with 2 turns: 9 straight steps + 2 landings

The measures of the box may vary

MEASUREMENTS valid for all the configurations

The SYSTEM FOR ADJUSTING THE HEIGHT BETWEEN THE STEPS (RISE) allows you to:

- Obtain different heights between floors with the same number of steps.
- Obtain the height between the floors as required with more or fewer steps (this means you can find the best compromise between the step height and the space occupied by the staircase).

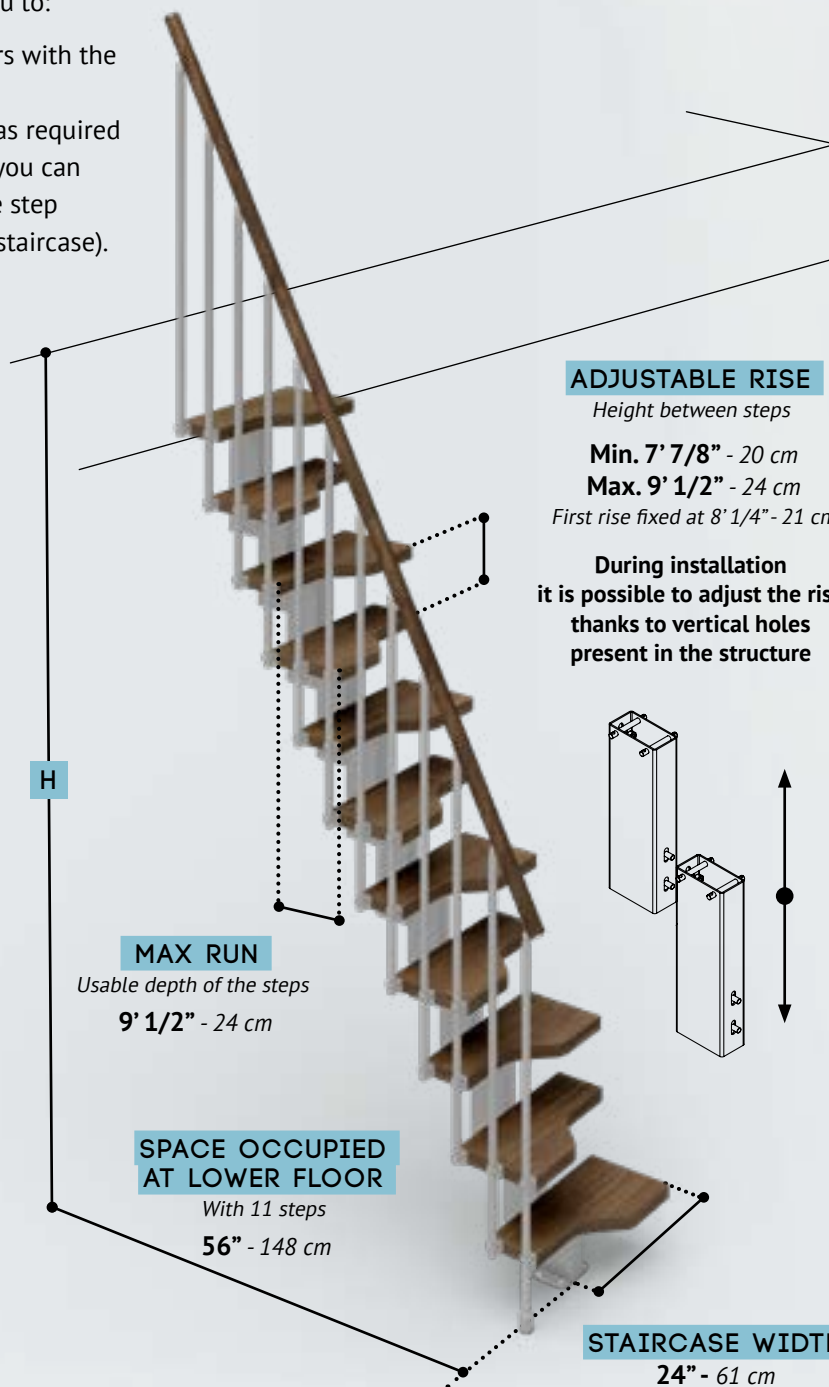

NUMBER STEPS	HEIGHT BETWEEN FLOORS (H)
9 steps <i>1 box</i>	Min. 6' 7" - 201 cm Max. 7' 9" - 237 cm
10 steps <i>1 box</i>	Min. 7' 3" - 221 cm Max. 8' 6 3/4" - 261 cm
11 steps <i>1 box</i>	Min. 7' 11" - 241 cm Max. 9' 4" - 285 cm
12 steps <i>1 box + 1 extra step</i>	Min. 8' 6 3/4" - 261 cm Max. 10' 1" - 309 cm
13 steps <i>1 box + 2 extra steps</i>	Min. 9' 2" - 281 cm Max. 10' 11" - 333 cm
14 steps <i>1 box + 3 extra steps</i>	Min. 9' 10" - 301 cm Max. 11' 8" - 357 cm

ADJUSTABLE RISE
Height between steps
Min. 7' 7/8" - 20 cm
Max. 9' 1/2" - 24 cm
First rise fixed at 8' 1/4" - 21 cm

During installation it is possible to adjust the rise thanks to vertical holes present in the structure

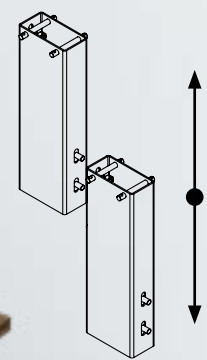

Add more steps to reach greater heights.

- **H = Finished floor to finished floor height.**
- **Top step fixed one rise below finished upper floor.**
- **Ceiling opening width:** staircase width + 2" (5 cm).

DIRECTION OF ASCENT

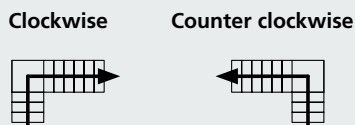

TURN POSITION

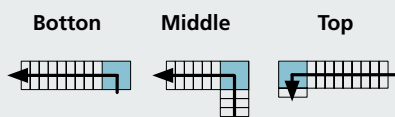

ACCESSORIES

Extra step (with structure and railing).	Railing for 11 steps (External side).	Balustrade for upper floor 39" (100 cm).	Safety bars under step.

SMALL

The Small staircase designed to optimise the available space with a practical and safe solution. The shape of the steps allows the space occupied to be decreased without losing the comfort of run up the stair.







Previous pages

Small 11 steps, straight configuration. Steps, structure, railing natural finish and white handrail.

Left

Close-up of step shape with alternating tread. Steps, structure, railing natural finish and white handrail.

Right page

Small 11 steps, straight configuration. Natural finish steps, structure, railing and silver grey handrail.



MATERIALS AND COLORS

STEPS

- In birch plywood, thickness 1' 1/8" (29 mm)
- Excellent stability and high mechanical strength
- Non-toxic water-based coating: 3 layers of paint

HANDRAIL

- In plastic material in the same colour as the structure

STRUCTURE

- Steel modular elements
- Powder coated with matt scratch proof finish

RAILING

- Painted steel vertical rails matching the colour of the structure

Wood colour (steps)

Natural



Steel colour (structure and railing)

White

Silver grey



CONFIGURATIONS

STRAIGHT

WITH 1 TURN

WITH 2 TURNS

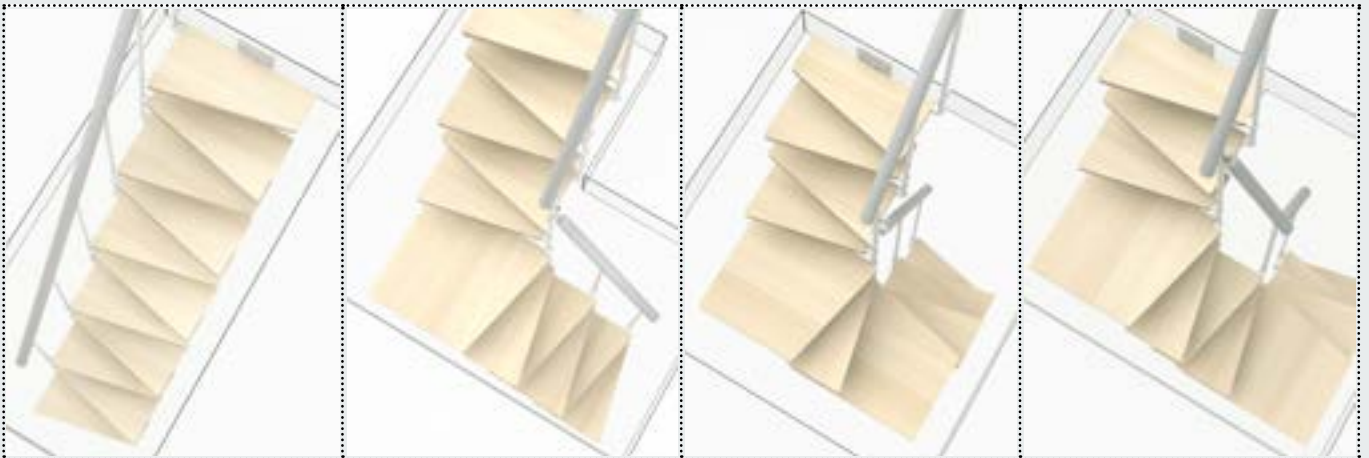

STAGGERED AND SHAPED STEPS: reduce the space occupied by the staircase without sacrificing comfort.

PACKAGE

1 box

=

1 complete staircase with 11 steps

Structure, steps, railing (internal side), handrail

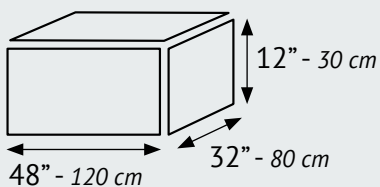

Choose between:

Straight staircase: 11 straight steps

Staircase with 1 turn: 10 straight steps + 1 landing

Staircase with 2 turns: 9 straight steps + 2 landings

The measures of the box may vary

MEASUREMENTS valid for all the configurations

The **SYSTEM FOR ADJUSTING THE HEIGHT BETWEEN THE STEPS (RISE)** allows you to:

- Obtain different heights between floors with the same number of steps.
- Obtain the height between the floors as required with more or fewer steps (this means you can find the best compromise between the step height and the space occupied by the staircase).

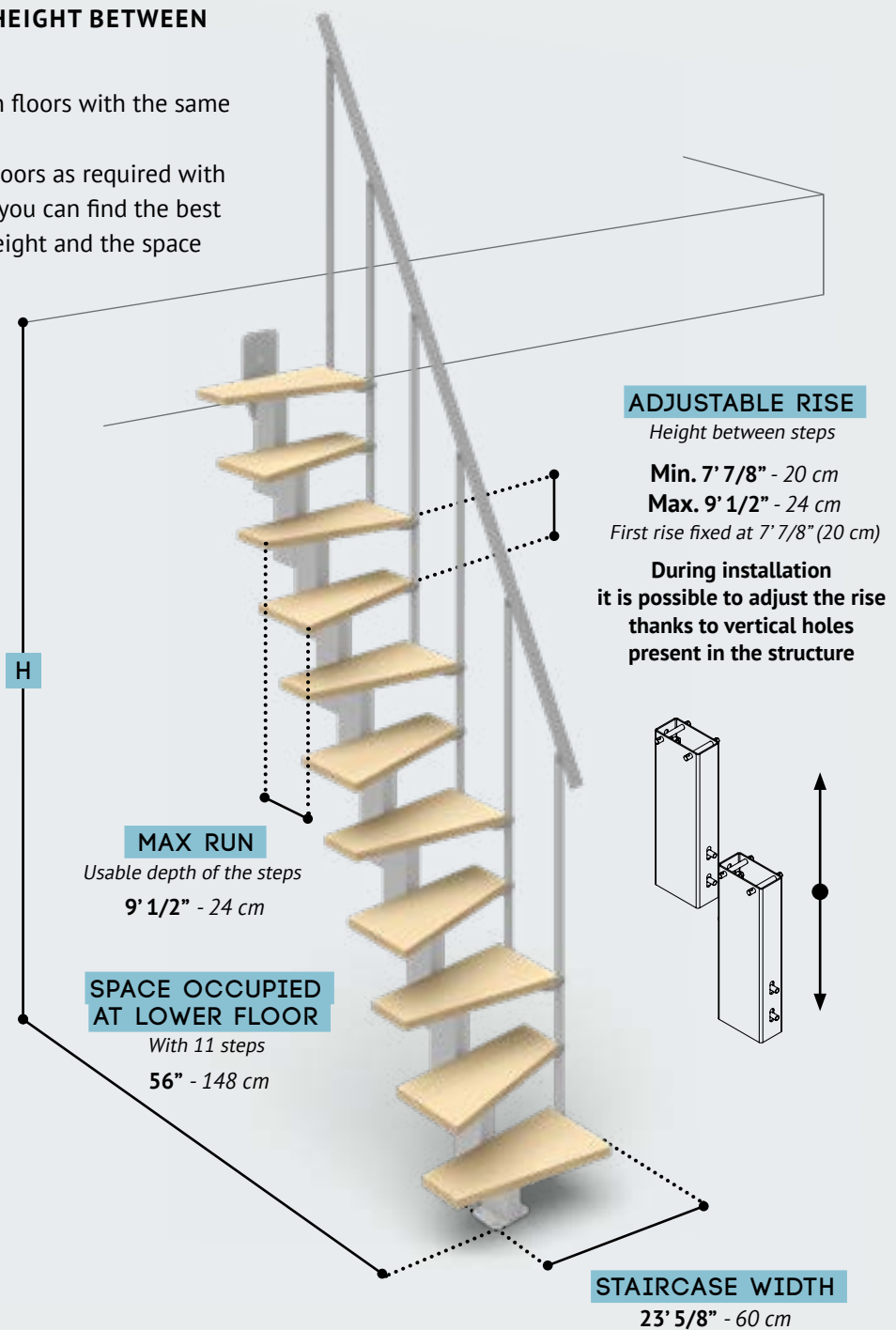

N. STEPS	HEIGHT BETWEEN FLOORS (H)
9 steps <i>1 box</i>	Min. 6' 6 3/4" - 200 cm Max. 7' 8 7/8" - 236 cm
10 steps <i>1 box</i>	Min. 7' 2 5/8" - 220 cm Max. 8' 6 3/8" - 260 cm
11 steps <i>1 box</i>	Min. 7' 10 1/2" - 240 cm Max. 9' 3 3/4" - 284 cm
12 steps <i>1 box + 1 extra step</i>	Min. 8' 6 3/8" - 260 cm Max. 10' 1 1/4" - 308 cm
13 steps <i>1 box + 2 extra steps</i>	Min. 9' 2 1/4" - 280 cm Max. 10' 10 3/4" - 332 cm
14 steps <i>1 box + 3 extra steps</i>	Min. 9' 10 1/8" - 300 cm Max. 11' 8 1/8" - 356 cm

ADJUSTABLE RISE
Height between steps
Min. 7' 7/8" - 20 cm
Max. 9' 1/2" - 24 cm
First rise fixed at 7' 7/8" (20 cm)
During installation it is possible to adjust the rise thanks to vertical holes present in the structure

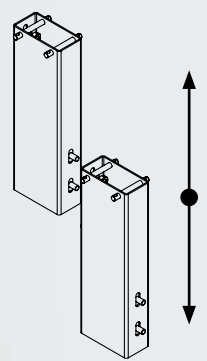

Add more steps to reach greater heights.

- **H** = Finished floor to finished floor height.
- **Top step fixed one rise below finished upper floor.**
- **Ceiling opening width:** staircase width + 2" (5 cm).

DIRECTION OF ASCENT



TURN POSITION

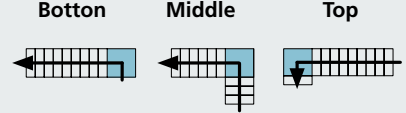

ACCESSORIES

Extra step (with structure and railing).	Railing for 11 steps (External side).	Balustrade for upper floor 39" (100 cm).	Safety bars under step.





SPIRAL STAIRCASES

HOOP

The simple, functional spiral staircase for interiors with steel structure and steps in Natural beech wood. The shape of the steps has been designed to reduce the overall space occupied and optimise the available space.









Left page
Hoop 13 steps. Natural finish steps, structure, railing and silver grey handrail.

Previous pages
Hoop 13 steps. Steps, structure, railing natural finish and white handrail.

Above
Close-up of first step and curve angle of the steps. Steps, structure, railing natural finish and white handrail.

MATERIALS AND COLORS

STEPS

- In birch plywood, thickness 1' 1/8" (29 mm)
- Excellent stability and high mechanical strength
- Non-toxic water-based coating: 3 layers of paint

HANDRAIL

- In plastic material in the same colour as the structure

STRUCTURE

- Steel modular elements
- Powder coated with matt scratch proof finish

RAILING

- Steel vertical columns painted in the same colour as the structure (distance between the columns less than 3' 7/8" - 10 cm)

Wood colour (steps)

Natural



Steel colour (structure and railing)

White

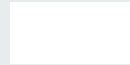

Silver grey



CONFIGURATIONS

SQUARE OPENING
(stair landing included)



ROUND OPENING
(stair landing included)



DIRECT LANDING AT THE FLOOR SLAB
(stair without landing)



UNIVERSAL LANDING WITH 60° OPENING: adaptable to any opening during installation.

4 STEPS EVERY 90°: this reduces the space occupied without losing comfort.

PACKAGE

1 box =

1 complete staircase of 13 steps (landing included)

Structure, steps, railing, handrail

or

1 complete staircase with 12 steps (without landing)

Structure, steps, railing, handrail

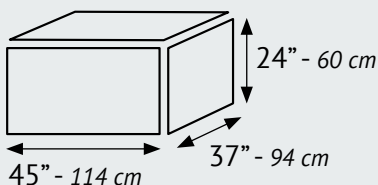

The measures of the box may vary

MEASUREMENTS valid for all the configurations

The **SYSTEM FOR ADJUSTING THE HEIGHT BETWEEN THE STEPS (RISE)** allows you to:

- Obtain different heights between floors with the same number of steps.
- Obtain the height between the floors as required with more or fewer steps (this means you can find the best compromise between the step height and the space occupied by the staircase).

ADJUSTABLE RISE

Height between steps

Min. 8' 1/8" - 20,5 cm
Max. 9' 1/2" - 24 cm

During installation it is possible to adjust the rise by changing the number of spacers

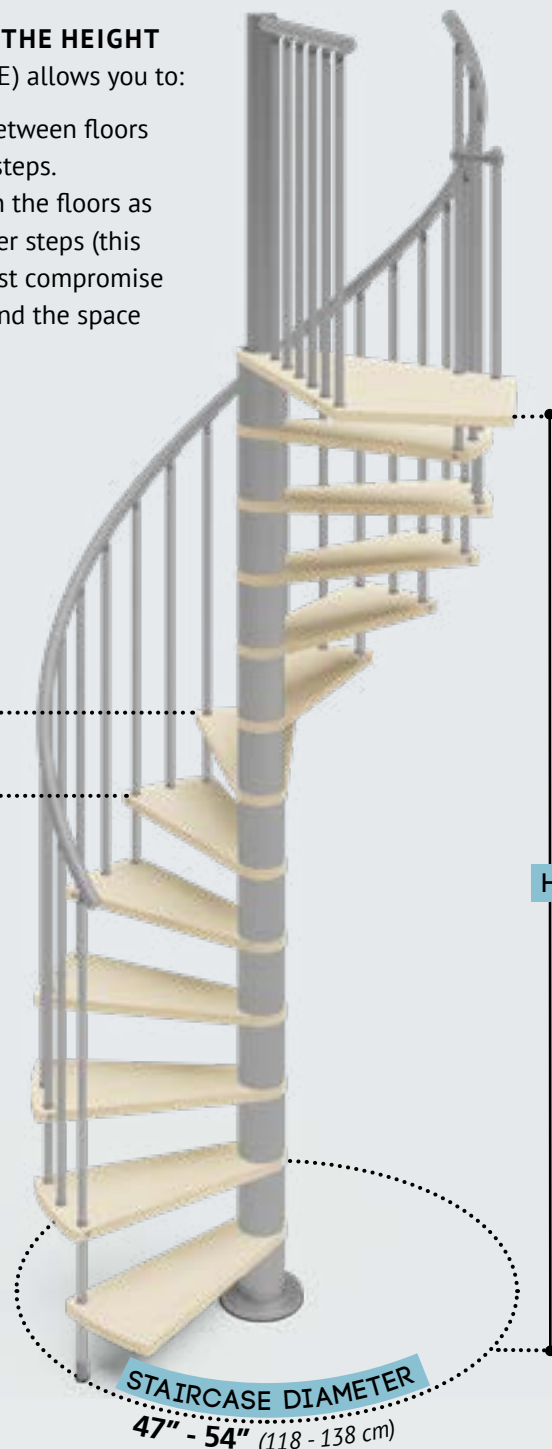
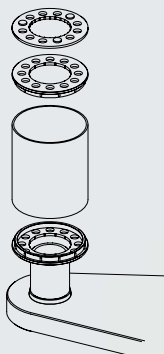

N. STEPS	HEIGHT BETWEEN FLOORS (H)
10 steps 1 box	Min. 6' 8 3/4" - 205 cm Max. 7' 10 1/2" - 240 cm
11 steps 1 box	Min. 7' 5" - 226 cm Max. 8' 8" - 264 cm
12 steps 1 box	Min. 8' 1" - 246 cm Max. 9' 5 3/8" - 288 cm
13 steps 1 box	Min. 8' 9 1/8" - 267 cm Max. 10' 2 7/8" - 312 cm
14 steps 1 box + 1 extra step	Min. 9' 5" - 287 cm Max. 11' 1/4" - 336 cm
15 steps 1 box + 2 extra steps	Min. 10' 1 1/4" - 308 cm Max. 11' 9 3/4" - 360 cm
16 steps 1 box + 3 extra steps	Min. 10' 9 1/8" - 328 cm Max. 12' 7 1/8" - 384 cm

Add more steps to reach greater heights.

- H = Finished floor to finished floor height.
- Staircase landing included: top universal landing fixed at the same level as the finished upper floor.
- Staircase without landing: top step fixed one rise below finished upper floor.
- Ceiling opening diameter: staircase diameter + 2" (5 cm).

DIRECTION OF ASCENT

Clockwise Counter clockwise

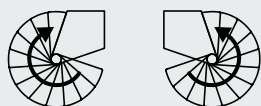

ACCESSORIES

Extra step (with structure and railing).

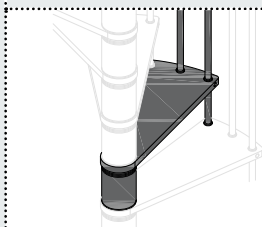

Balustrade for upper floor 39" (100 cm).

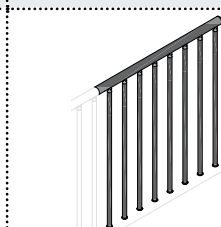

Extra section of internal post (needed for heights over 10' 5 5/8" - 319 cm).



PHOLA

The modular spiral staircase which combines the warmth of solid wood with the strength of steel, offering a variety of combinations of diameters and finishes.







Previous pages
Phola 13 steps. Steps and handrail Sand 27, structure and railing white.

Left
Close-up of the first step and anchoring to the railing. Steps and handrails Sand 27, structure and railing anthracite grey.

Above
Phola 13 steps. Steps and handrail Walnut 25, structure and railing anthracite grey.

Right page
Phola 13 steps. Steps Sand 27, handrail in white plastic, structure and railing white. Close-up of universal top landing.



MATERIALS AND COLORS

STEPS

- Solid beech wood, 1' 5/8" (40 mm) thickness
- No knots or splits, maximum stability and mechanical strength thanks to Finger Joint technology
- Non-toxic water-based coating: 3 layers of paint

HANDRAIL

- In plastic material matching the colour of the structure

STRUCTURE

- Steel modular elements
- Powder coated with matt scratch proof finish

RAILING

- Painted steel vertical rails matching the colour of the structure

Wood colour (steps)

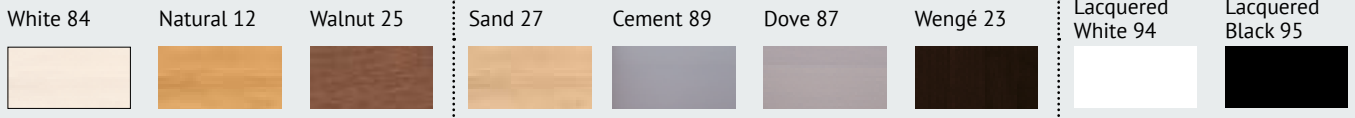

Steel colour (structure and railing)

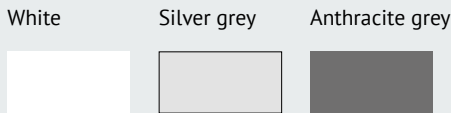

CONFIGURATIONS

SQUARE OPENING

ROUND OPENING

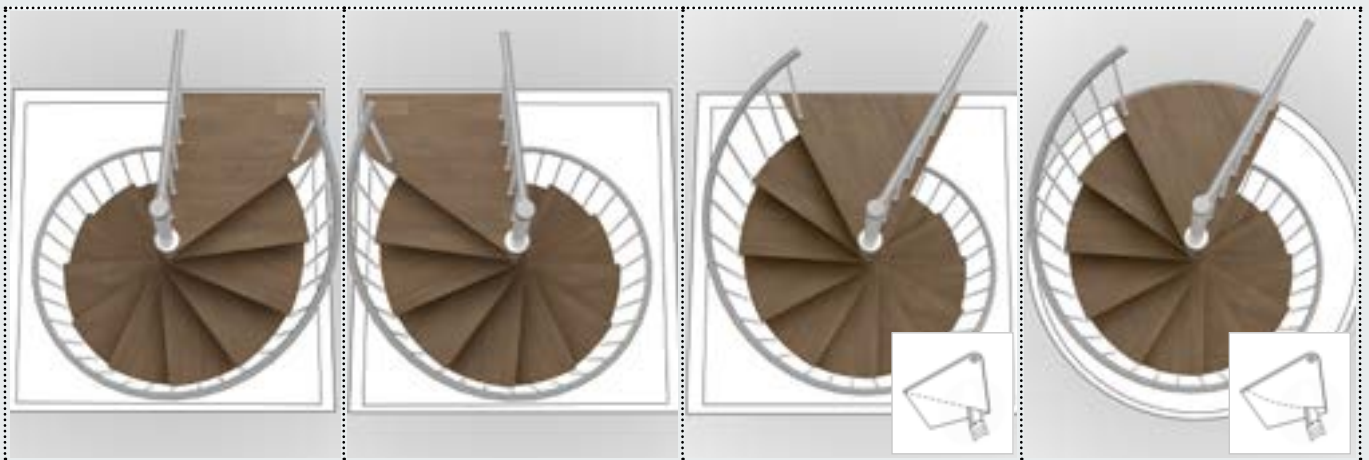

UNIVERSAL LANDING WITH 60° OPENING: adaptable to any opening during installation

PACKAGE

1 box = **1 complete staircase of 13 steps** (landing included)
Structure, steps, railing, handrail

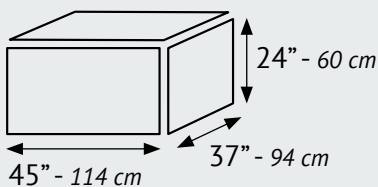

The measures of the box may vary

MEASUREMENTS valid for all the configurations

The **SYSTEM FOR ADJUSTING THE HEIGHT BETWEEN THE STEPS (RISE)** allows you to:

- Obtain different heights between floors with the same number of steps.
- Obtain the height between the floors as required with more or fewer steps (this means you can find the best compromise between the step height and the space occupied by the staircase).

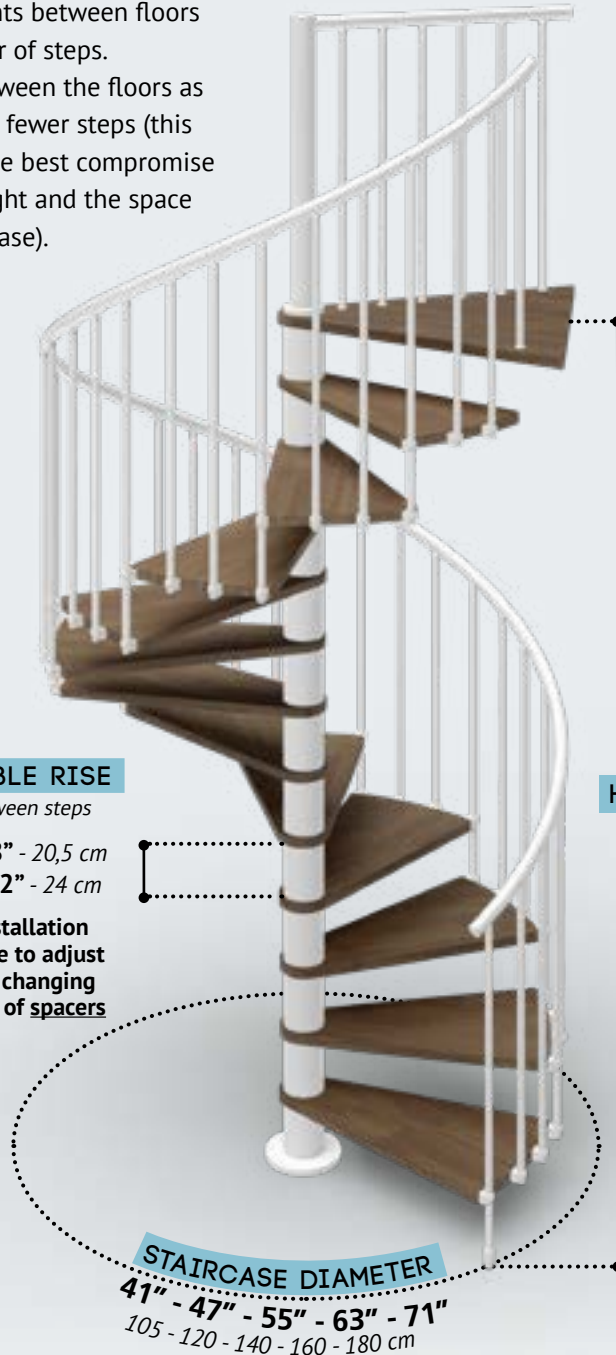

ADJUSTABLE RISE

Height between steps

Min. 8' 1/8" - 20,5 cm
Max. 9' 1/2" - 24 cm

During installation it is possible to adjust the rise by changing the number of spacers

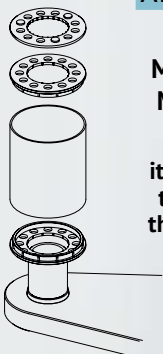

N. STEPS	HEIGHT BETWEEN FLOORS (H)
10 steps 1 box	Min. 6' 8 3/4" - 205 cm Max. 7' 10 1/2" - 240 cm
11 steps 1 box	Min. 7' 5" - 226 cm Max. 8' 8" - 264 cm
12 steps 1 box	Min. 8' 1" - 246 cm Max. 9' 5 3/8" - 288 cm
13 steps 1 box	Min. 8' 9 1/8" - 267 cm Max. 10' 2 7/8" - 312 cm
14 steps 1 box + 1 extra step	Min. 9' 5" - 287 cm Max. 11' 1/4" - 336 cm
15 steps 1 box + 2 extra steps	Min. 10' 1 1/4" - 308 cm Max. 11' 9 3/4" - 360 cm
16 steps 1 box + 3 extra steps	Min. 10' 9 1/8" - 328 cm Max. 12' 7 1/8" - 384 cm

Add more steps to reach greater heights.

- H = Finished floor to finished floor height.
- Top universal landing fixed at the same level as the finished upper floor.
- Ceiling opening diameter: staircase diameter + 2" (5 cm).

DIRECTION OF ASCENT

Clockwise Counter clockwise

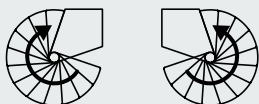

ACCESSORIES

Extra step (with structure and railing).	Wooden handrail (not available for the diam. 3' 5 3/8" - 105 cm)	Balustrade for upper floor 39" (100 cm).	Extra section of internal post (needed for heights over 10' 5 5/8" - 319 cm)

TEKLA

The square base spiral staircase is perfect for installing between two or more walls. The shape of the steps has been specifically developed to make the most of all the space with a practical and functional solution.





Previous pages

Tekla 13 steps. Steps and handrail White 84, white structure and railing.

Below

*Close-up of steps and anchoring to the railing.
Steps and handrail White 84, white structure and railing.*

Right page

*Phola 13 steps. Steps Walnut 25, handrail in black plastic, structure and railing anthracite grey.
Close-up of universal top landing.*





MATERIALS AND COLORS

STEPS

- Solid beech wood, 1' 5/8" (40 mm) thickness
- No knots or splits, maximum stability and mechanical strength thanks to Finger Joint technology
- Non-toxic water-based coating: 3 layers of paint

HANDRAIL

- In plastic material matching the colour of the structure

STRUCTURE

- Steel modular elements
- Powder coated with matt scratch proof finish

RAILING

- Steel vertical columns painted in the same colour as the structure (distance between the columns less than 3' 7/8" - 10 cm)

Wood colour (steps)

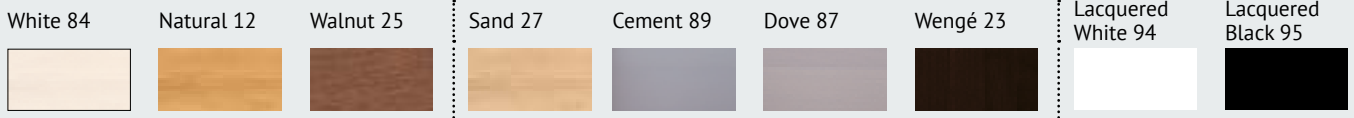

Steel colour (structure and railing)

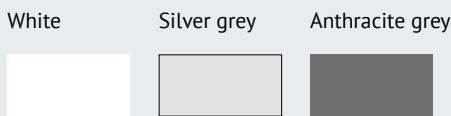

CONFIGURATIONS

SQUARE OPENING



UNIVERSAL LANDING WITH 60° OPENING: adaptable to any opening during installation.

SQUARE BASE SPIRAL STAIRCASE: adapts to corners perfectly.

PACKAGE

1 box = **1 complete staircase of 13 steps** (landing included)
Structure, steps, railing (two sides), handrail

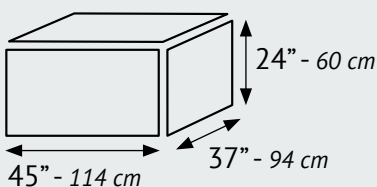

The measures of the box may vary

MEASUREMENTS valid for all the configurations

The **SYSTEM FOR ADJUSTING THE HEIGHT BETWEEN THE STEPS (RISE)** allows you to:

- Obtain different heights between floors with the same number of steps.
- Obtain the height between the floors as required with more or fewer steps (this means you can find the best compromise between the step height and the space occupied by the staircase).

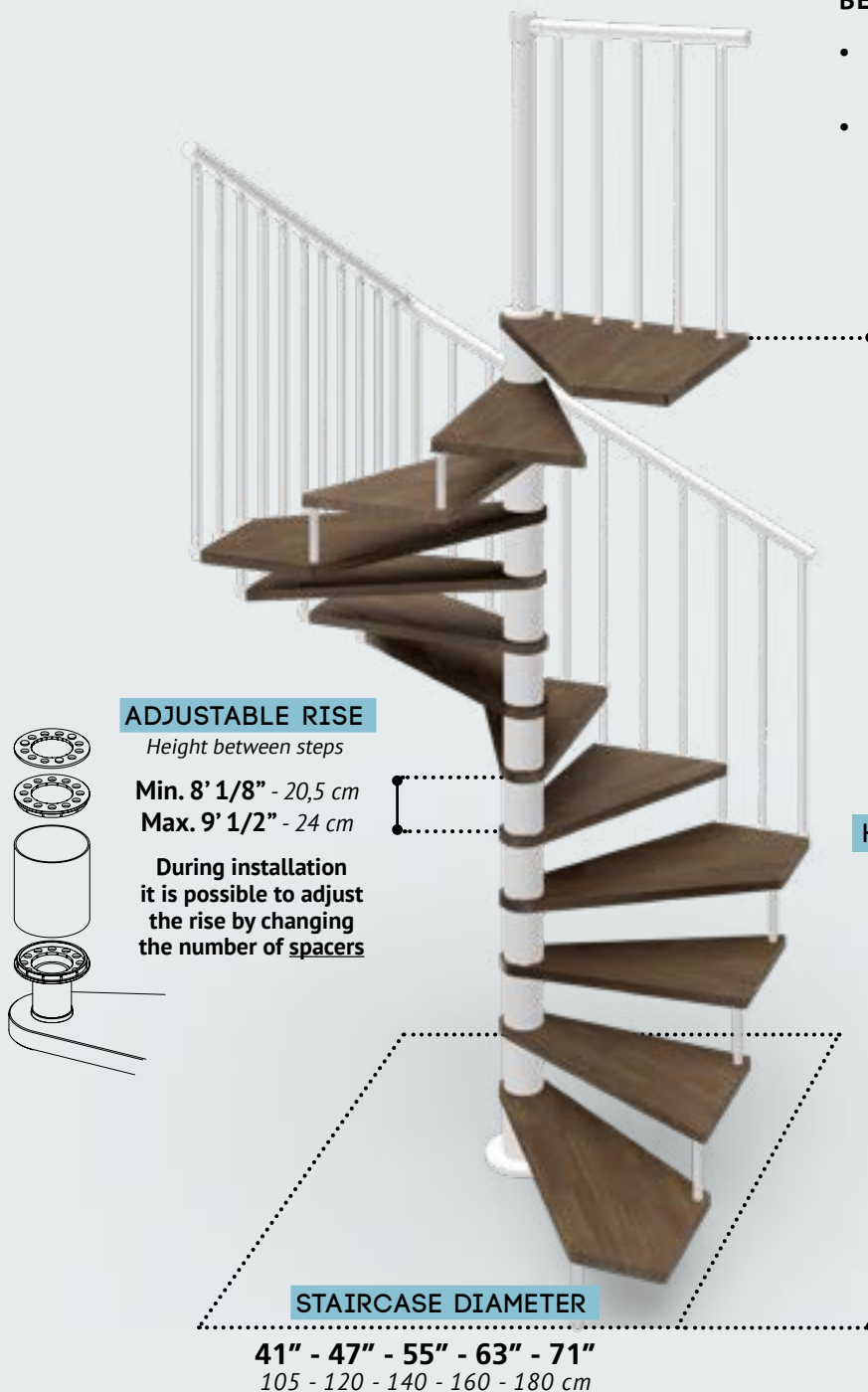

N. STEPS	HEIGHT BETWEEN FLOORS (H)
10 steps 1 box	Min. 6' 8 3/4" - 205 cm Max. 7' 10 1/2" - 240 cm
11 steps 1 box	Min. 7' 5" - 226 cm Max. 8' 8" - 264 cm
12 steps 1 box	Min. 8' 1" - 246 cm Max. 9' 5 3/8" - 288 cm
13 steps 1 box	Min. 8' 9 1/8" - 267 cm Max. 10' 2 7/8" - 312 cm
14 steps 1 box + 1 extra step	Min. 9' 5" - 287 cm Max. 11' 1/4" - 336 cm
15 steps 1 box + 2 extra steps	Min. 10' 1 1/4" - 308 cm Max. 11' 9 3/4" - 360 cm
16 steps 1 box + 3 extra steps	Min. 10' 9 1/8" - 328 cm Max. 12' 7 1/8" - 384 cm

Add more steps to reach greater heights.

- H = Finished floor to finished floor height.
- Top universal landing fixed at the same level as the finished upper floor.
- Ceiling opening diameter: staircase diameter + 2" (5 cm).

DIRECTION OF ASCENT

Clockwise Counter clockwise



ACCESSORIES

Extra step (with structure).	Railing (one side).	Wooden handrail (one side).	Balustrade for upper floor 39" (100 cm).	Extra section of internal post (needed for heights over 10' 5 5/8" - 319 cm).





GAMIA METAL

The spiral staircase completely in steel available in various diameters to adapt to any requirement.





Previous pages

Gamia Metal 13 steps. Steps, structure, railing silver grey. Railing and handrail grey.

Left page

Gamia Metal 13 steps. Steps, structure, railing and handrail white.

Above

Close-up of step and anti-slip strip available in red, yellow, blue and green

MATERIALS AND COLORS

STEPS

- In painted steel
- Maximum stability and mechanical strength
- Matt, scratch-proof, oven-dried epoxy powder coating
- Anti slip thanks to the strips on the steps

HANDRAIL

- In plastic material

STRUCTURE

- Composed of painted steel spacers on which the steps are welded
- Powder coated with matt scratch proof finish

RAILING

- Vertical columns in painted steel (distance between the columns less than 3' 7/8" - 10 cm)

Steel colors (steps, structure and railing)

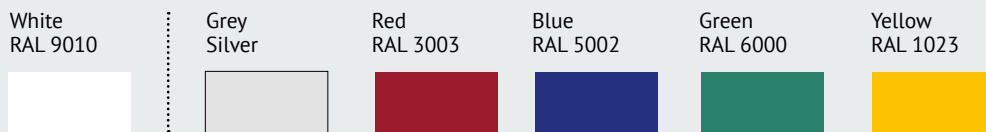

CONFIGURATIONS

SQUARE OPENING

ROUND OPENING

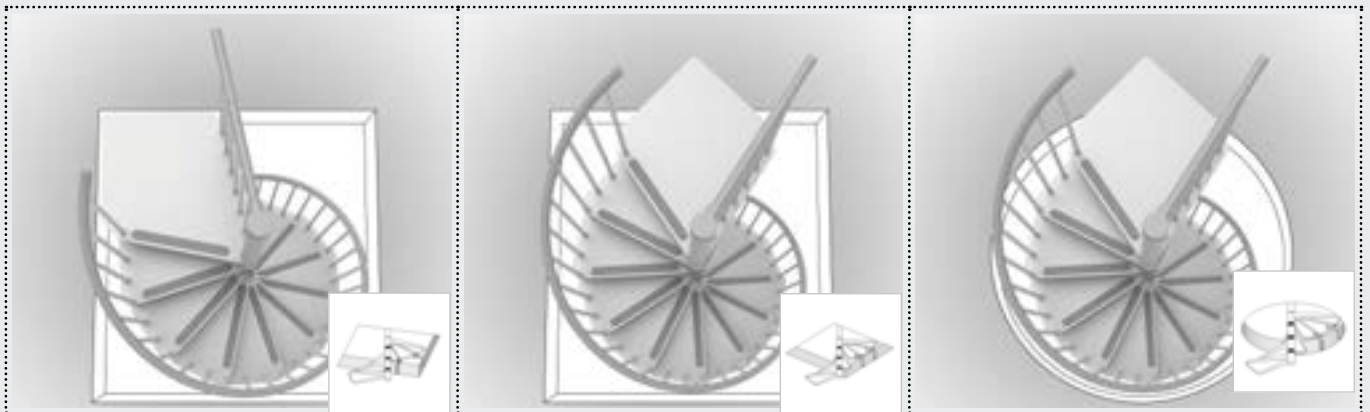

UNIVERSAL LANDING WITH 60° OPENING: adaptable to any opening during installation.

PACKAGE

1 box = **1 complete staircase of 13 steps** (landing included)
Structure, steps, railing, handrail

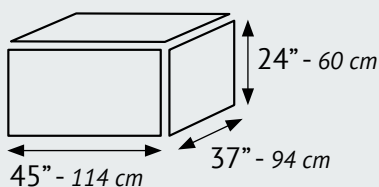

The measures of the box may vary

MEASUREMENTS valid for all the configurations

The **SYSTEM FOR ADJUSTING THE HEIGHT BETWEEN THE STEPS (RISE)** allows you to:

- Obtain different heights between floors with the same number of steps.
- Obtain the height between the floors as required with more or fewer steps (this means you can find the best compromise between the step height and the space occupied by the staircase).

ADJUSTABLE RISE

Height between steps

Min. 8' 1/4" - 21 cm
Max. 9' - 23 cm

During installation it is possible to adjust the rise by changing the height of the spacers

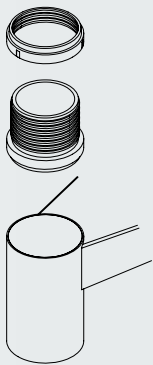

N. STEPS	HEIGHT BETWEEN FLOORS (H)
10 steps 1 box	Min. 6' 10 5/8" - 210 cm Max. 7' 6 1/2" - 230 cm
11 steps 1 box	Min. 7' 7" - 231 cm Max. 8' 3 5/8" - 253 cm
12 steps 1 box	Min. 8' 3 1/4" - 252 cm Max. 9' 5/8" - 276 cm
13 steps 1 box	Min. 8' 10 1/2" - 273 cm Max. 9' 9 3/4" - 299 cm
14 steps 1 box + 1 extra step	Min. 9' 7 3/4" - 294 cm Max. 10' 6 3/4" - 322 cm
15 steps 1 box + 2 extra steps	Min. 10' 4" - 315 cm Max. 11' 3 7/8" - 345 cm
16 steps 1 box + 3 extra steps	Min. 11' 1/4" - 336 cm Max. 12' 7/8" - 368 cm

Add more steps to reach greater heights.

- H = Finished floor to finished floor height.
- Top universal landing fixed at the same level as the finished upper floor.
- Ceiling opening diameter: staircase diameter + 2" (5 cm).

160?
non c'è negli altri cataloghi!

DIRECTION OF ASCENT

Clockwise Counter clockwise

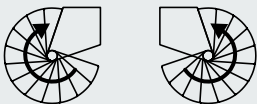

ACCESSORIES

Extra step (with structure and railing).	Balustrade for upper floor 39" (100 cm).	Extra section of internal post (needed for heights over 10' 5 5/8" - 319 cm).





EXTERIOR ZINK

The solid and strong outdoor galvanised spiral staircase, perfect for every location and atmospheric condition.

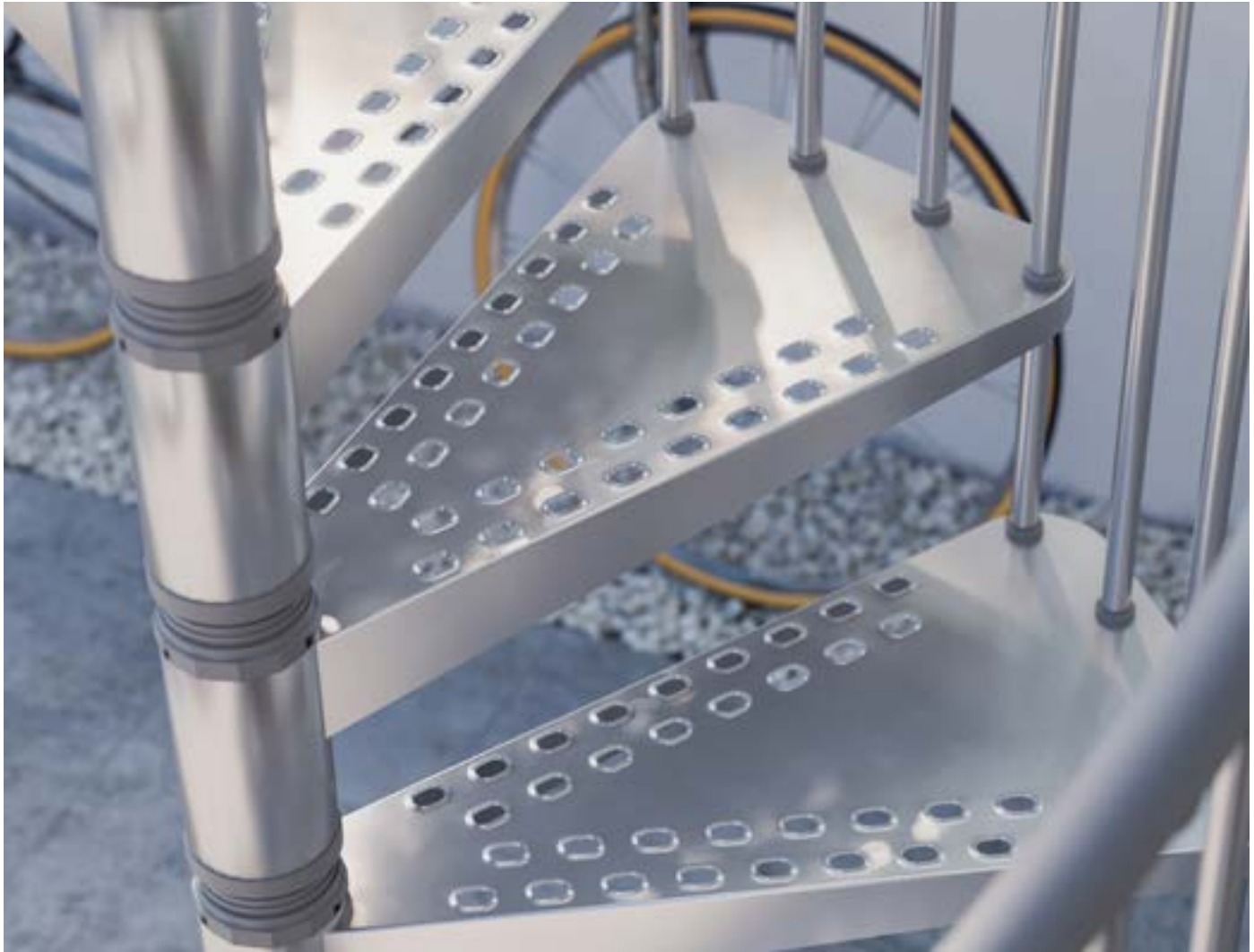

**Previous pages**

Exterior Zink 13 steps in galvanized steel.

Left page

Exterior Zink 13 steps in galvanized steel and painted white (RAL 9010).

Above

Detail of the departure step in galvanized steel and non-slip embossing.

MATERIALS AND COLORS

STEPS

- In hot-dip galvanised steel
- Anti-slip raised pattern
- Maximum stiffness and resistance to trampling

HANDRAIL

- In plastic material

STRUCTURE

- Consisting of hot-dip galvanised steel spacers attached to the steps

RAILING

- Hot-dip galvanised steel vertical columns (distance between the columns less than 3' 7/8" - 10 cm)

Steel colors (steps, structure and railing)



Note

Hot-dip galvanising is the best steel protection against corrosion and atmospheric agents: any imperfection of the surface is the natural consequence of this treatment.

CONFIGURATIONS

SQUARE OPENING

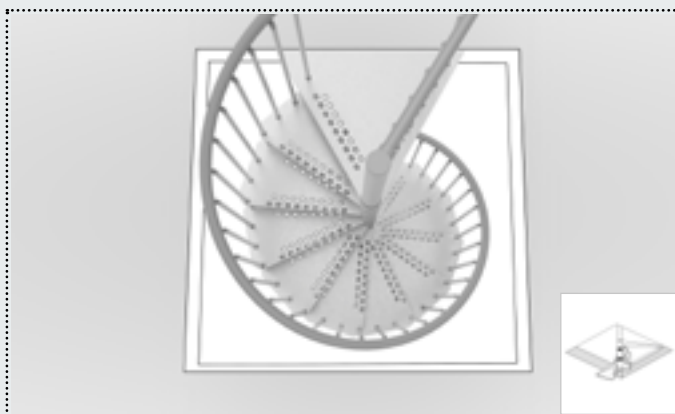

DIRECT LANDING AT THE FLOOR SLAB

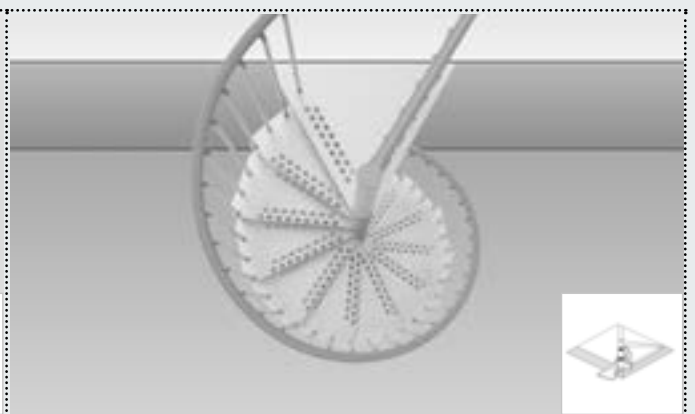

LANDING WITH 60° OPENING

PACKAGE

1 box = **1 complete staircase of 13 steps** (landing included)
Structure, steps, railing, handrail

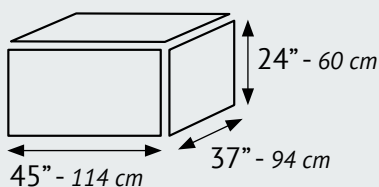

The measures of the box may vary

MEASUREMENTS valid for all the configurations

The **SYSTEM FOR ADJUSTING THE HEIGHT BETWEEN THE STEPS (RISE)** allows you to:

- Obtain different heights between floors with the same number of steps.
- Obtain the height between the floors as required with more or fewer steps (this means you can find the best compromise between the step height and the space occupied by the staircase).

ADJUSTABLE RISE

Height between steps

Min. 8' 1/4" - 21 cm
Max. 9' - 23 cm

During installation it is possible to adjust the rise by modifying the number of spacers

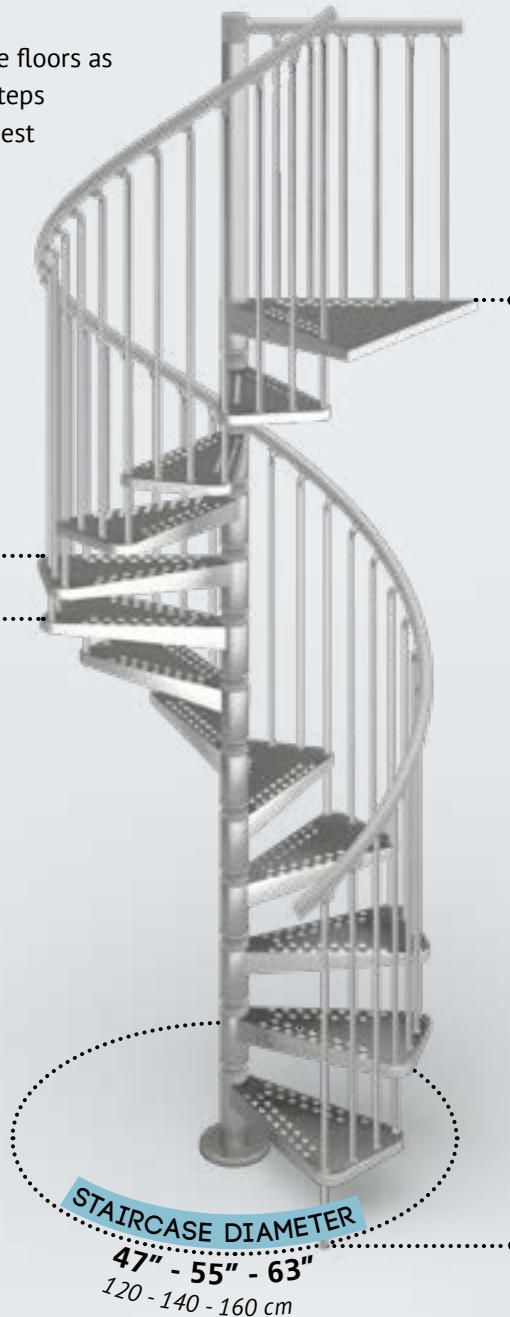
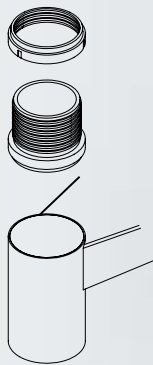

N. STEPS	HEIGHT BETWEEN FLOORS (H)
10 steps 1 box	Min. 6' 10 5/8" - 210 cm Max. 7' 6 1/2" - 230 cm
11 steps 1 box	Min. 7' 7" - 231 cm Max. 8' 3 5/8" - 253 cm
12 steps 1 box	Min. 8' 3 1/4" - 252 cm Max. 9' 5/8" - 276 cm
13 steps 1 box	Min. 8' 10 1/2" - 273 cm Max. 9' 9 3/4" - 299 cm
14 steps 1 box + 1 extra step	Min. 9' 7 3/4" - 294 cm Max. 10' 6 3/4" - 322 cm
15 steps 1 box + 2 extra steps	Min. 10' 4" - 315 cm Max. 11' 3 7/8" - 345 cm
16 steps 1 box + 3 extra steps	Min. 11' 1/4" - 336 cm Max. 12' 7/8" - 368 cm

Add more steps to reach greater heights.

- H = Finished floor to finished floor height.
- Top universal landing fixed at the same level as the finished upper floor.
- Ceiling opening diameter: staircase diameter + 2" (5 cm).

DIRECTION OF ASCENT

Clockwise Counter clockwise

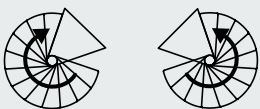

ACCESSORIES

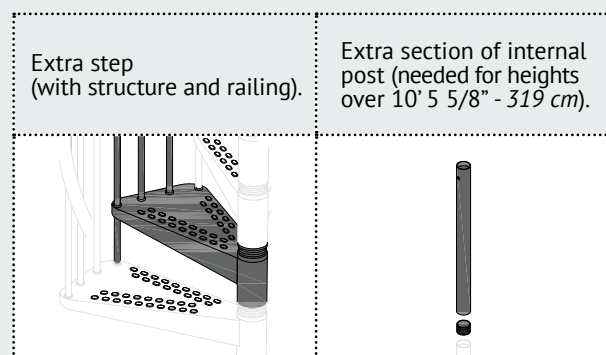

COLORS

Wood colour (steps and handrail)



White 84



Natural 12



Walnut 25



Sand 27



Cement 89



Dove 87



Wengé 23

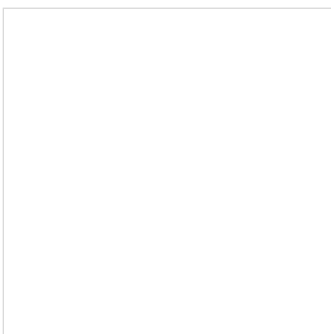

Lacquered White 94

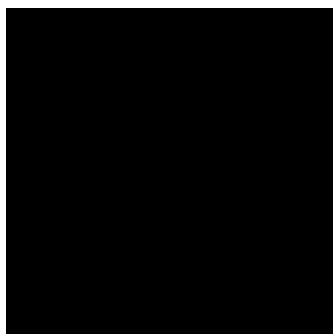

Lacquered Black 95



Steel colors (steps, structure and railing)

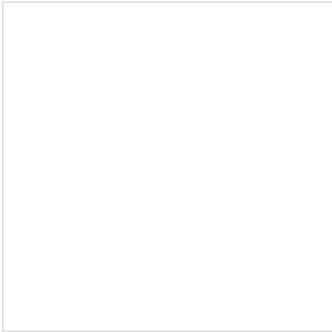

White

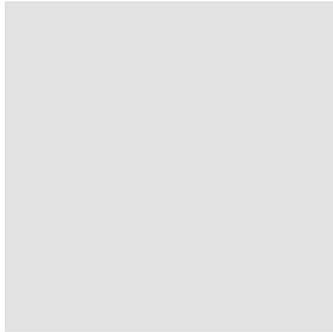

Silver grey



Anthracite grey



Red RAL 3003



Blue RAL 5002



Green RAL 6000



Yellow RAL 1023



Galvanised



www.rintal.com